

2024

CATÁLOGO
DE PRODUTOS

Linha
PLÁSTICOS



WETZEL S.A.

Fundada em 1932, em Joinville/SC, a Wetzel é referência nos segmentos em que atua, atendendo à demandas específicas e com alto grau de exigência.

A empresa possui atualmente mais de 45.000m² de área e conta com mais de 1.000 funcionários.

Oferece um portfólio diversificado para quem precisa de soluções inovadoras e competitivas, por isso procura sempre trabalhar em parceria com seus clientes e desenvolve produtos que atendam as necessidades de projetos com alto grau de exigência técnica.

A fim de garantir a qualidade e a excelência da produção, busca melhorias contínuas em cada fase dos processos.

É uma organização dinâmica, em contínua transformação e expansão, com atuação consolidada no mercado brasileiro e no exterior.

UNIDADES DE NEGÓCIOS

COMPONENTES PARA
INSTALAÇÕES **ELÉTRICAS**
E **ILUMINAÇÃO INDUSTRIAL**

COMPONENTES
AUTOMOTIVOS EM
ALUMÍNIO E FERRO



A Wetzal desenvolveu novos produtos para atender às necessidades das instalações elétricas aparentes em PVC, que são resultados das experiências no mercado, bem como das normas técnicas vigentes.

Produzidos em matérias-primas plásticas de alta qualidade, os produtos se destacam pelo excelente acabamento, encaixes precisos, grande resistência química e isolamento elétrico. No que se refere à propagação de chamas, são classificados como auto-extinguíveis.

As aplicações dos produtos **Wetzal Plastik** são destinadas ao comércio e indústria, atendendo diversos segmentos como: logístico (centros de distribuição), comercial (shoppings e escritórios), áreas limpas (hospitais, cozinhas industriais e frigoríficos) além de usinas fotovoltaicas e até mesmo ambientes residenciais.



ÍNDICE

10 CONCEITOS

CINZA

POLIWETZEL

(CAIXA DE DERIVAÇÃO MÓVEL)



21 Combos



28 Caixas e Acessórios

TAMPAS PARA POLIWETZEL



30 Modulares



31 Cegas e Monoblocos

CONDULETZEL

(CAIXA DE DERIVAÇÃO FIXA)



34 Caixas

TAMPAS PARA CONDULETZEL



35 Modulares



37 Cegas e Monoblocos

ELETRODUTOS



40 Plastik Classe A



40 Plastik Pesado

TUBOS



40 Plastik Max



41 Plastik Standard

ACESSÓRIOS



41 Abraçadeira



41 Luva Sem Rosca



42 Bucha de Redução Sem Rosca



42 Curva 45° Plastik Max



42 Curva 90° Plastik Max



43 Curva 90° Plastik Standard



43 Cotovelo 90°

POLIWETZEL

(CAIXA DE DERIVAÇÃO MÓVEL)



47 Combos



60 Caixas e Acessórios

TAMPAS PARA POLIWETZEL



62 Modulares



63 Cegas e Monoblocos



68 Bucha de Redução Sem Rosca



69 Curva 45° Plastik Max



69 Curva 90° Plastik Max



69 Curva 90° Plastik Standard



69 Cotovelo 90°

ELETRODUTOS



67 Plastik Pesado

TUBOS



67 Plastik Max



67 Plastik Standard

ACESSÓRIOS



68 Abraçadeira



68 Luva Sem Rosca

POLIWETZEL

(CAIXA DE DERIVAÇÃO MÓVEL)



73 Combos



80 Caixas e Acessórios

TAMPAS PARA POLIWETZEL



82 Modulares



83 Cegas e Monoblocos

CONDULETZEL

(CAIXA DE DERIVAÇÃO FIXA)



87 Caixas

TAMPAS PARA CONDULETZEL



88 Modulares



90 Cegas e Monoblocos

ELETRODUTOS



93 Plastik Classe A



93 Plastik Pesado

TUBOS



93 Plastik Max



94 Plastik Standard

ACESSÓRIOS



94 Abraçadeira



94 Luva Sem Rosca



95 Bucha de Redução Sem Rosca



95 Curva 45° Plastik Max



95 Curva 90° Plastik Max



96 Curva 90° Plastik Standard



96 Cotovelo 90°

POLIWETZEL

(CAIXA DE DERIVAÇÃO MÓVEL)



101 Combos



108 Caixas e Acessórios

TAMPAS PARA POLIWETZEL



110 Modulares



111 Cegas e Monoblocos

TUBOS



115 Plastik Max



115 Plastik Standard

ACESSÓRIOS



116 Abraçadeira



116 Luva
Sem Rosca



116 Bucha de Redução
Sem Rosca



117 Curva 90°
Plastik Max



117 Curva 90°
Plastik Standard



117 Cotovelo 90°

VERMELHO

POLIWETZEL

(CAIXA DE DERIVAÇÃO MÓVEL)



121 Combos



123 Caixas e Acessórios

TAMPAS PARA POLIWETZEL



125 Modulares



126 Cegas e Monoblocos

CONDULETZEL

(CAIXA DE DERIVAÇÃO FIXA)



128 Caixas

TAMPAS PARA CONDULETZEL



129 Modulares



130 Cegas

ELETRODUTOS



132 Plastik Classe A



132 Plastik Pesado

TUBOS



132 Plastik Max



133 Plastik Standard

ACESSÓRIOS



133 Abraçadeira



133 Luva Sem Rosca



134 Bucha de Redução Sem Rosca



134 Curva 45° Plastik Max



134 Curva 90° Plastik Max



135 Curva 90° Plastik Standard



135 Cotovelo 90°

LINHA INDUSTRIE

 **137** Mecanismos Modulares

PRENSA CABOS

PRENSA CABOS HEAVY DUTY

 **140** Rosca BSP

 **141** Rosca NPT

 **141** Rosca PG

PRENSA CABOS CONVENCIONAL

 **142** Rosca BSP

 **143** Rosca NPT

 **144** Rosca PG

 **146** Rosca Métrica

CAIXAS DE PASSAGEM

 **149** Caixas

 **150** Suporte

 **150** Chassi

 **150** Cola

CAIXAS DE DERIVAÇÃO

POLIWETZEL® - Caixa de Derivação Móvel

Poliwetzcel® é a marca da Wetzel para a linha de caixas de derivação de conexão móvel, também conhecidas como caixas múltiplas. A marca Poliwetzcel® foi projetada e desenvolvida para instalações elétricas aparentes leves e abrigadas de intempéries. Está disponível em cinco cores e é composta por caixas, conectores, tampões, tampas e união.



CINZA



PRETO



BRANCO



BRANCO PRO



VERMELHO

CAIXAS

Disponíveis em dois tamanhos, ambas com seis entradas.



CAIXA PEQUENA - PARA INSTALAÇÕES 1/2" e 3/4"



CAIXA GRANDE - PARA INSTALAÇÕES 1/2", 3/4" e 1"

CONECTORES

PARA CAIXA PEQUENA - 1/2" e 3/4"



PARA CAIXA GRANDE - 1/2", 3/4" e 1"



INSTALAÇÃO DOS CONECTORES SAÍDAS UNIFICADAS 1/2" E 3/4" NA CAIXA GRANDE DE 1"

PASSO 1

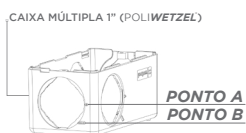

As caixas múltiplas possuem dois relevos conforme mostra a imagem acima, o PUNTO A e B

PASSO 2



Identifique o PUNTO C em relevo no conector saídas unificadas

PASSO 3

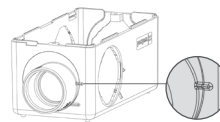

Posicione o PUNTO C em relevo no conector rente ao PUNTO A da caixa múltipla

PASSO 4



Rotacione o conector do PUNTO A até o PUNTO B para finalizar a instalação do conector saídas unificadas



O conector de saída unificada manterá o eletroduto na mesma altura da abraçadeira, a fim de garantir o paralelismo do eletroduto com a parede.

TAMPAS

As tampas possuem um sistema de fixação por encaixe de pressão, que dispensa o uso de parafusos e garante praticidade na instalação. Os modelos de tampas disponíveis para Poliwetzel® são as cegas, monoblocos e modulares.

MELHOR ESCOLHA

A solução **modular** (tampa modular + mecanismo industrie) proporciona mais versatilidade e agilidade para a instalação e evita problemas de incompatibilidade com os diversos modelos de mecanismos monoblocos disponíveis no mercado.

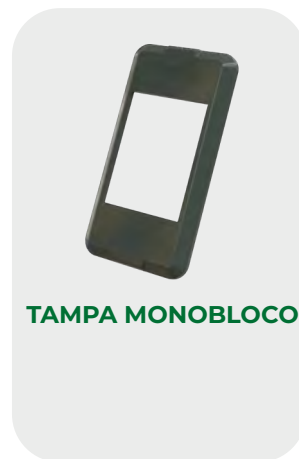
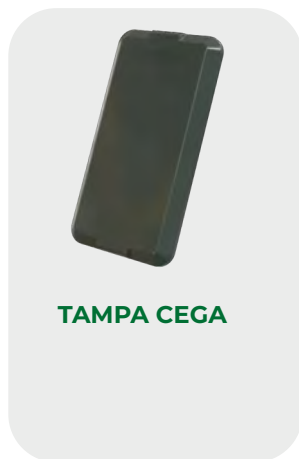

UNIÃO

A união para caixas Poliwetzel®, possibilita a montagem de caixas em séries (dupla, tripla ou mais).

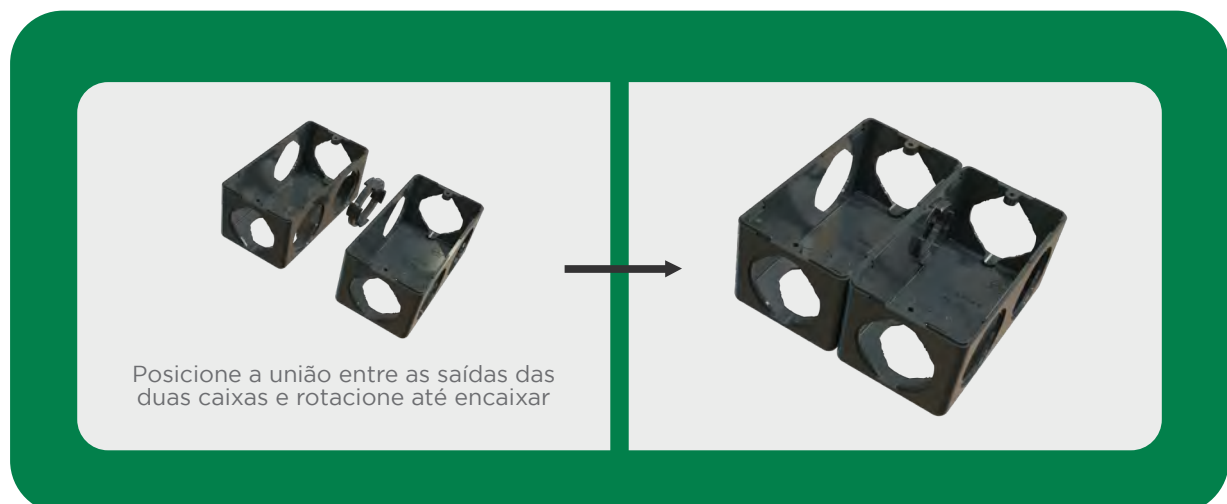

CONDULETZEL® - Caixa de Derivação Fixa

Conduletzel® é a marca da Wetzel para a linha de caixas de derivação de conexão fixa. A marca Conduletzel® foi projetada e desenvolvida para instalações elétricas aparentes leves, que necessitam maior resistência mecânica. Está disponível em três cores e é composta por caixas e tampas.



CAIXAS

Disponíveis em dois tamanhos, oito modelos e três bitolas.



TAMPAS

As tampas são fixadas nas caixas por meio de parafusos. Os modelos de tampas disponíveis para Conduletzel® são as cegas, monoblocos e modulares.

MELHOR ESCOLHA

A solução **modular** (tampa modular + mecanismo industrie) proporciona mais versatilidade e agilidade para a instalação e evita problemas de incompatibilidade com os diversos modelos de mecanismos monoblocos disponíveis no mercado.

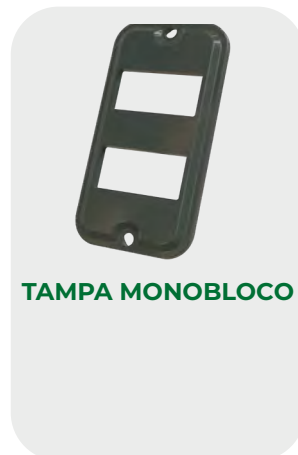
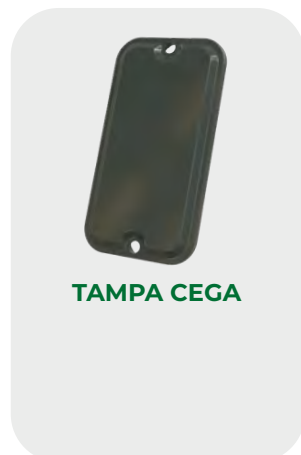

Todas as tampas para as caixas Conduletzel® são acompanhadas por dois parafusos

COMBOS POLIWETZEL®

As caixas de derivação de conexão móvel POLIWETZEL®, também conhecidas como caixas múltiplas, além de disponíveis de forma avulsa (caixas, tampas, conectores e tampões separadamente), também são disponibilizadas no sistema de combos.

Os combos tratam-se de conjuntos montados, que incluem caixa, tampões, conectores, tampa cega ou tampa modular, com ou sem mecanismo(s) modular(es) de interruptor(es) e tomada(s), nas mais diversas configurações. Uma solução completa e econômica.

Os combos são disponibilizados nas bitolas 3/4" e 1", nas cores Cinza, Branco, Branco Pro, Preto, Preto All Black e Vermelho.

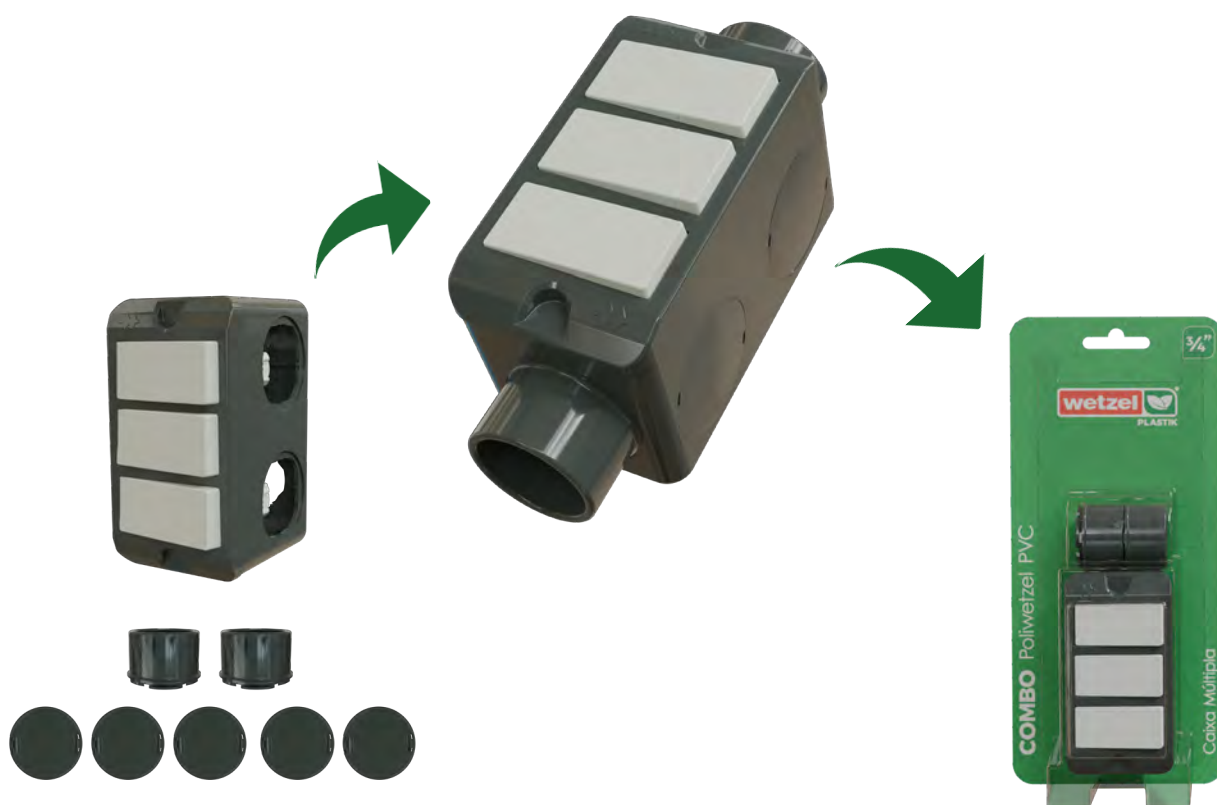

ELETRODUTOS

Os eletrodutos são disponibilizados em dois modelos sem rosca e estão disponíveis nas bitolas (1/2", 3/4", 1", 1.1/4", 1.1/2" e 2").

ELETRODUTO PLASTIK CLASSE A

Parede extra para ambientes **industriais** e/ou sujeitos à grandes **solicitações mecânicas**.



Recomenda-se o uso de uma abraçadeira a cada 1 metro

ELETRODUTO PLASTIK PESADO

Segurança para instalações **profissionais** em ambientes **industriais**.



Recomenda-se o uso de uma abraçadeira a cada 1 metro

*A barra de eletroduto possui 3m.

TUBOS

Os tubos são disponibilizados em dois modelos sem rosca e estão disponíveis em três bitolas (1/2", 3/4" e 1").

ELETROWETZEL PLASTIK MAX

Versatilidade e custo-benefício para ambientes **comerciais**.



Recomenda-se o uso de uma abraçadeira a cada 0,75 metro

ELETROWETZEL PLASTIK STANDARD

Qualidade para ambientes **residenciais** e/ou com finalidade **decorativa**.



Recomenda-se o uso de uma abraçadeira a cada 0,5 metro

*A barra de eletrowetzel possui 3m.

Importante: A taxa de ocupação interna do eletroduto é determinada pelo item 6.2.11.1.6 da ABNT NBR5410.



1 CONDUTOR
Limitado a 53% de ocupação



2 CONDUTORES
Limitados a 31% de ocupação

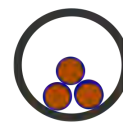

3 CONDUTORES OU MAIS
Limitados a 40% de ocupação

PRENSA CABOS

Os prensa cabos têm um papel importante na fixação mecânica dos cabos e na proteção das instalações, pois garantem que não ocorra a permeação de líquidos e sólidos.

Disponíveis em:

- Modelos: **Convencional** (IP54) e **Heavy Duty** (IP68);
- Cores: cinza e preto;
- Tipos de roscas: BSP, NPT, PG e métrica.



CAIXAS DE PASSAGEM

As caixas de passagem Wetzel são produzidas em PSAI (poliestireno de alto impacto) e possuem vedação na tampa.

Os modelos disponíveis variam de tamanho e altura, com ou sem chassi interno. São disponibilizados, também, suportes para fixação que evitam a furação na caixa, não comprometendo seu grau de proteção.

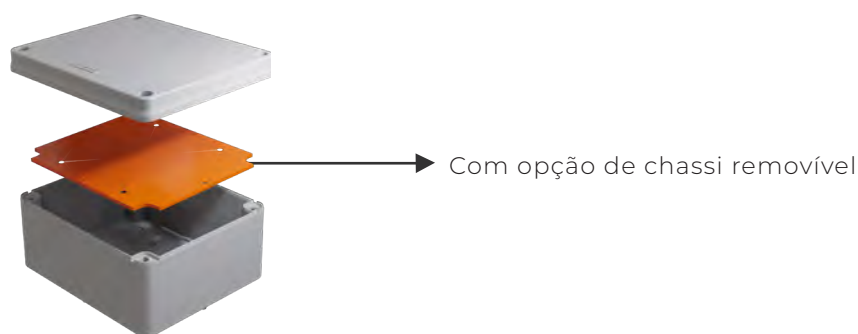
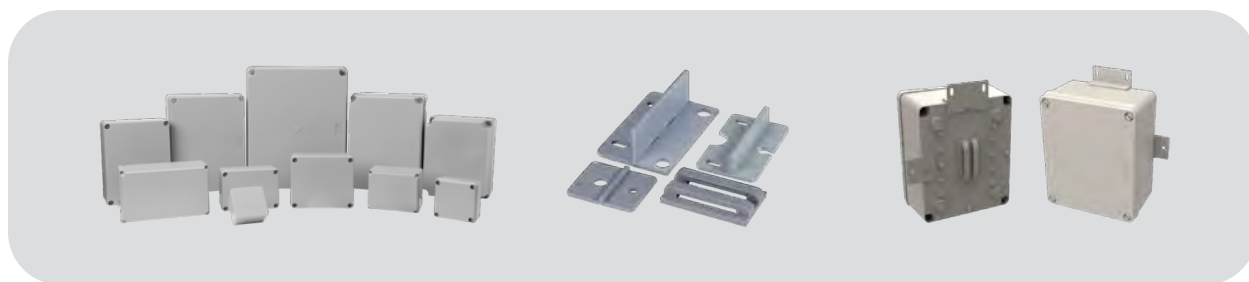

RECOMENDAÇÃO DE INSTALAÇÃO

Para garantir o Grau de Proteção IP, utilize os suportes para caixa de passagem. Recomenda-se que os suportes sejam fixados nas caixas com a Cola Permabond. Ambos os produtos estão disponíveis na página 144.

GRAU DE PROTEÇÃO IP

(IP - INGRESS PROTECTION)

São medidas aplicadas ao invólucro de um equipamento elétrico, definidas pela norma ABNT NBR IEC 60529.

SEGUNDO NUMERAL - GRAU DE PROTEÇÃO CONTRA LÍQUIDOS

Não protegido	Protegido contra quedas verticais de gotas d'água	Protegido contra quedas verticais de gotas d'água para uma inclinação máxima de 15 graus	Protegido contra água aspergida de um ângulo de ± 60 graus	Protegido contra projeções de água	Protegido contra jatos d'água	Protegido contra jatos potentes de água	Protegido contra imersão temporária	Protegido contra submersão	Protegido contra jatos d'água com alta pressão e temperatura
0	1	2	3	4	5	6	7	8	9

PRIMEIRO NUMERAL - GRAU DE PROTEÇÃO CONTRA OBJETOS SÓLIDOS

Não protegido	0	IP00	IP01	IP02															
Protegido contra objetos sólidos com \varnothing maior que 50mm	1	IP10	IP11	IP12															
Protegido contra objetos sólidos com \varnothing maior que 12mm	2	IP20	IP21	IP22	IP23														
Protegido contra objetos sólidos com \varnothing maior que 2,5mm	3	IP30	IP31	IP32	IP33	IP34													
Protegido contra objetos sólidos com \varnothing maior que 1mm	4	IP40	IP41	IP42	IP43	IP44	IP45	IP46											
Protegido contra poeira depressão: 200mm de coluna d'água. Máxima aspiração de ar: 80 vezes o volume do invólucro	5					IP54	IP55	IP56											
Totalmente protegido contra a poeira. Mesmo procedimento de teste	6						IP65	IP66	IP67	IP68	IP69								

LINHA CINZA

Indicada para áreas industriais como **galpões logísticos, salas comerciais**, entre outros diversos locais.



Não propaga
chamas



Não conduz
eletricidade



Praticidade
no encaixe



Apta para
reciclagem



COMBOS POLIWETZEL®

PÁGINAS
20 a 26



POLI WETZEL®

PÁGINAS
27 a 32



CONDULETZEL®

PÁGINAS
33 a 38

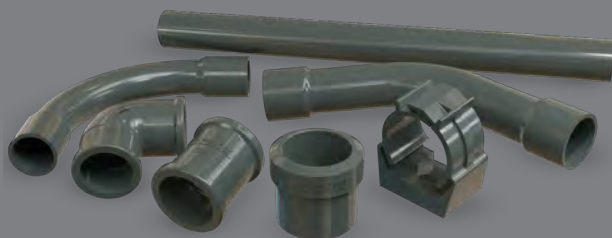

ELETRODUTOS, TUBOS E ACESSÓRIOS

PÁGINAS
39 a 43

COMBOS POLIWETZEL®

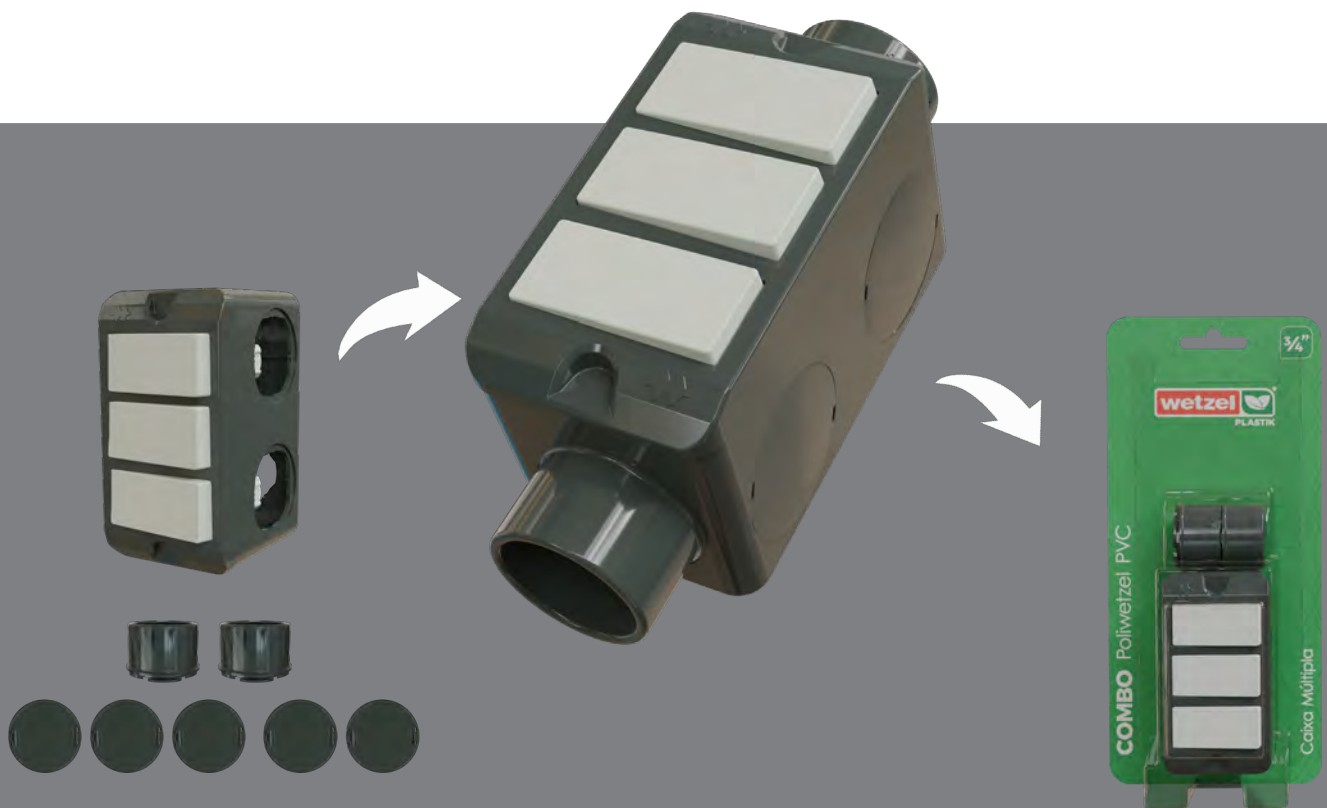

CONHEÇA OS COMBOS

- DISPONÍVEIS NAS BITOLAS 3/4" E 1"
- SOLUÇÕES COMPLETAS COM MECANISMOS MODULARES
- PRÁTICOS PARA ARMAZENAR E PREPARAR INSTALAÇÕES







COMBO POLIWETZEL®

CAIXA DE DERIVAÇÃO MÓVEL TIPO L COM 2 CONECTORES e 5 TAMPÕES









TAMPA CEGA

	CÓDIGO	REFERÊNCIA	DESCRIÇÃO	BITOLA	QT. EMB.
	E017202020	LPC6-15 CB PVC CZ CEGO	TAMPA CEGA	3/4"	12

TAMPA MODULAR (SEM MECANISMO)

	CÓDIGO	REFERÊNCIA	DESCRIÇÃO	BITOLA	QT. EMB.
	E017202135	LPC6-15 CB PVC CZ S/ MÓDULO	TRÊS POSTOS S/ MÓDULO	3/4"	12

TAMPA MODULAR (COM 1 MECANISMO)

	CÓDIGO	REFERÊNCIA	DESCRIÇÃO	BITOLA	QT. EMB.
	E017202027	LPC6-15 CB PVC CZ 1 T 10A	UMA TOMADA 10A	3/4"	12
	E017202028	LPC6-15 CB PVC CZ 1INT SIM	UM INTERRUPTOR SIMPLES	3/4"	12
	E017202032	LPC6-15 CB PVC CZ 1 T 20A	UMA TOMADA 20A	3/4"	12
	E017202037	LPC6-15 CB PVC CZ 1 RJ45 CAT 5E	UMA TOMADA RJ45 CAT 5E	3/4"	12
	E017202038	LPC6-15 CB PVC CZ 1 RJ11	UMA TOMADA RJ11	3/4"	12
	E017202128	LPC6-15 CB PVC CZ 1 INT PARAL	UM INTERRUPTOR PARALELO	3/4"	12
	E017202137	LPC6-15 CB PVC CZ 1 RJ45 CAT 6	UMA TOMADA RJ45 CAT 6	3/4"	12
	E017202138	LPC6-15 CB PVC CZ 1 USB 5.0V 2.0A	UMA TOMADA USB 5.0V 2.0A	3/4"	12

COMBO POLIWETZEL® PVC CINZA

COMBO POLIWETZEL®

CAIXA DE DERIVAÇÃO MÓVEL TIPO L COM 2 CONECTORES e 5 TAMPÕES













TAMPA MODULAR (COM 2 MECANISMOS)

	CÓDIGO	REFERÊNCIA	DESCRIÇÃO	BITOLA	QT. EMB.
	E017202023	LPC6-15 CB PVC CZ 1 T 10A 1 INT SIM	UMA TOMADA 10A + UM INTERRUPTOR SIMPLES	3/4"	12
	E017202026	LPC6-15 CB PVC CZ 1 RJ45 CAT 5E 1 RJ11	UMA TOMADA RJ45 CAT 5E + UMA TOMADA RJ11	3/4"	12
	E017202029	LPC6-15 CB PVC CZ 2 T 10A	DUAS TOMADAS 10A	3/4"	12
	E017202030	LPC6-15 CB PVC CZ 2 INT SIM	DOIS INTERRUPTORES SIMPLES	3/4"	12
	E017202031	LPC6-15 CB PVC CZ 1 T 20A 1 INT SIM	UMA TOMADA 20A + UM INTERRUPTOR SIMPLES	3/4"	12
	E017202035	LPC6-15 CB PVC CZ 2 T 20A	DUAS TOMADAS 20A	3/4"	12
	E017202036	LPC6-15 CB PVC CZ 2 RJ45 CAT 5E	DUAS TOMADAS RJ45 CAT 5E	3/4"	12
	E017202123	LPC6-15 CB PVC CZ 1 T 10A 1 INT PARAL	UMA TOMADA 10A + UM INTERRUPTOR PARALELO	3/4"	12
	E017202126	LPC6-15 CB PVC CZ 1 RJ45 CAT 6 1 RJ11	UMA TOMADA RJ45 CAT 6 + UMA TOMADA RJ11	3/4"	12
	E017202130	LPC6-15 CB PVC CZ 2 INT PARAL	DOIS INTERRUPTORES PARALELOS	3/4"	12
	E017202131	LPC6-15 CB PVC CZ 1 T 20A 1 INT PARAL	UMA TOMADA 20A + UM INTERRUPTOR PARALELO	3/4"	12
	E017202136	LPC6-15 CB PVC CZ 2 RJ45 CAT 6	DUAS TOMADAS RJ45 CAT 6	3/4"	12

COMBO POLIWETZEL®

CAIXA DE DERIVAÇÃO MÓVEL TIPO L COM 2 CONECTORES e 5 TAMPÕES

TAMPA MODULAR (COM 3 MECANISMOS)

	CÓDIGO	REFERÊNCIA	DESCRIÇÃO	BITOLA	QT. EMB.
	E017202021	LPC6-15 CB PVC CZ 3 T 10A	TRÊS TOMADAS 10A	3/4"	12
	E017202022	LPC6-15 CB PVC CZ 3 INT SIM	TRÊS INTERRUPTORES SIMPLES	3/4"	12
	E017202024	LPC6-15 CB PVC CZ 2 T 10A 1 INT SIM	DUAS TOMADAS 10A + UM INTERRUPTOR SIMPLES	3/4"	12
	E017202025	LPC6-15 CB PVC CZ 2 INT SIM 1 T 10A	DOIS INTERRUPTORES SIMPLES + UMA TOMADA 10A	3/4"	12
	E017202033	LPC6-15 CB PVC CZ 2 T 20A 1 INT SIM	DUAS TOMADAS 20A + UM INTERRUPTOR SIMPLES	3/4"	12
	E017202034	LPC6-15 CB PVC CZ 2 INT SIM 1 T 20A	DOIS INTERRUPTORES SIMPLES + UMA TOMADA 20A	3/4"	12
	E017202039	LPC6-15 CB PVC CZ 3 T 20A	TRÊS TOMADAS 20A	3/4"	12
	E017202122	LPC6-15 CB PVC CZ 3 INT PARAL	TRÊS INTERRUPTORES PARALELOS	3/4"	12
	E017202124	LPC6-15 CB PVC CZ 2 T 10A 1 INT PARAL	DUAS TOMADAS 10A + UM INTERRUPTOR PARALELO	3/4"	12
	E017202125	LPC6-15 CB PVC CZ 2 INT PARAL 1 T 10A	DOIS INTERRUPTORES PARALELOS + UMA TOMADA 10A	3/4"	12
	E017202133	LPC6-15 CB PVC CZ 2 T 20A 1 INT PARAL	DUAS TOMADAS 20A + UM INTERRUPTOR PARALELO	3/4"	12
	E017202134	LPC6-15 CB PVC CZ 2 INT PARAL 1 T 20A	DOIS INTERRUPTORES PARALELOS + UMA TOMADA 20A	3/4"	12

COMBO POLIWETZEL® PVC CINZA

COMBO POLIWETZEL®

CAIXA DE DERIVAÇÃO MÓVEL TIPO L COM 2 CONECTORES e 5 TAMPÕES









TAMPA CEGA

	CÓDIGO	REFERÊNCIA	DESCRIÇÃO	BITOLA	QT. EMB.
	E017202040	LPC6-20 CB PVC CZ CEGO	TAMPA CEGA	1"	12

TAMPA MODULAR (SEM MECANISMO)

	CÓDIGO	REFERÊNCIA	DESCRIÇÃO	BITOLA	QT. EMB.
	E017202155	LPC6-20 CB PVC CZ S/ MÓDULO	TRÊS POSTOS S/ MÓDULO	1"	12













TAMPA MODULAR (COM 1 MECANISMO)

	CÓDIGO	REFERÊNCIA	DESCRIÇÃO	BITOLA	QT. EMB.
	E017202047	LPC6-20 CB PVC CZ 1 T 10A	UMA TOMADA 10A	1"	12
	E017202048	LPC6-20 CB PVC CZ 1 INT SIM	UM INTERRUPTOR SIMPLES	1"	12
	E017202052	LPC6-20 CB PVC CZ 1 T 20A	UMA TOMADA 20A	1"	12
	E017202057	LPC6-20 CB PVC CZ 1 RJ45 CAT 5E	UMA TOMADA RJ45 CAT 5E	1"	12
	E017202058	LPC6-20 CB PVC CZ 1 RJ11	UMA TOMADA RJ11	1"	12
	E017202148	LPC6-20 CB PVC CZ 1 INT PARAL	UM INTERRUPTOR PARALELO	1"	12
	E017202157	LPC6-20 CB PVC CZ 1 RJ45 CAT 6	UMA TOMADA RJ45 CAT 6	1"	12
	E017202158	LPC6-20 CB PVC CZ 1 USB 5.0V 2.0A	UMA TOMADA USB 5.0V 2.0A	1"	12

COMBO POLIWETZEL®

CAIXA DE DERIVAÇÃO MÓVEL TIPO L COM 2 CONECTORES e 5 TAMPÕES

TAMPA MODULAR (COM 2 MECANISMOS)

	CÓDIGO	REFERÊNCIA	DESCRIÇÃO	BITOLA	QT. EMB.
	E017202043	LPC6-20 CB PVC CZ 1 T 10A 1 INT SIM	UMA TOMADA 10A + UM INTERRUPTOR SIMPLES	1"	12
	E017202046	LPC6-20 CB PVC CZ 1 RJ45 CAT 5E 1 RJ11	UMA TOMADA RJ45 CAT 5E + UMA TOMADA RJ11	1"	12
	E017202049	LPC6-20 CB PVC CZ 2 T 10A	DUAS TOMADAS 10A	1"	12
	E017202050	LPC6-20 CB PVC CZ 2 INT SIM	DOIS INTERRUPTORES SIMPLES	1"	12
	E017202051	LPC6-20 CB PVC CZ 1 T 20A 1 INT SIM	UMA TOMADA 20A + UM INTERRUPTOR SIMPLES	1"	12
	E017202055	LPC6-20 CB PVC CZ 2 T 20A	DUAS TOMADAS 20A	1"	12
	E017202056	LPC6-20 CB PVC CZ 2 RJ45 CAT 5E	DUAS TOMADAS RJ45 CAT 5E	1"	12
	E017202143	LPC6-20 CB PVC CZ 1 T 10A 1 INT PARAL	UMA TOMADA 10A + UM INTERRUPTOR PARALELO	1"	12
	E017202146	LPC6-20 CB PVC CZ 1 RJ45 CAT 6, 1 RJ11	UMA TOMADA RJ45 CAT 6 + UMA TOMADA RJ11	1"	12
	E017202150	LPC6-20 CB PVC CZ 2 INT PARAL	DOIS INTERRUPTORES PARALELOS	1"	12
	E017202151	LPC6-20 CB PVC CZ 1 T 20A 1 INT PARAL	UMA TOMADA 20A + UM INTERRUPTOR PARALELO	1"	12
	E017202156	LPC6-20 CB PVC CZ 2 RJ45 CAT 6	DUAS TOMADAS RJ45 CAT 6	1"	12

COMBO POLIWETZEL® PVC CINZA

COMBO POLIWETZEL®

CAIXA DE DERIVAÇÃO MÓVEL TIPO L COM 2 CONECTORES e 5 TAMPÕES

TAMPA MODULAR (COM 3 MECANISMOS)

	CÓDIGO	REFERÊNCIA	DESCRIÇÃO	BITOLA	QT. EMB.
	E017202041	LPC6-20 CB PVC CZ 3 T 10A	TRÊS TOMADAS 10A	1"	12
	E017202042	LPC6-20 CB PVC CZ 3 INT SIM	TRÊS INTERRUPTORES SIMPLES	1"	12
	E017202044	LPC6-20 CB PVC CZ 2 T 10A 1 INT SIM	DUAS TOMADAS 10A + UM INTERRUPTOR SIMPLES	1"	12
	E017202045	LPC6-20 CB PVC CZ 2 INT SIM 1 T 10A	DOIS INTERRUPTORES SIMPLES + UMA TOMADA 10A	1"	12
	E017202053	LPC6-20 CB PVC CZ 2 T 20A 1 INT SIM	DUAS TOMADAS 20A + UM INTERRUPTOR SIMPLES	1"	12
	E017202054	LPC6-20 CB PVC CZ 2 INT SIM 1 T 20A	DOIS INTERRUPTORES SIMPLES + UMA TOMADA 20A	1"	12
	E017202059	LPC6-20 CB PVC CZ 3 T 20A	TRÊS TOMADAS 20A	1"	12
	E017202142	LPC6-20 CB PVC CZ 3 INT PARAL	TRÊS INTERRUPTORES PARALELOS	1"	12
	E017202144	LPC6-20 CB PVC CZ 2 T 10A 1 INT PARAL	DUAS TOMADAS 10A + UM INTERRUPTOR PARALELO	1"	12
	E017202145	LPC6-20 CB PVC CZ 2 INT PARAL 1 T 10A	DOIS INTERRUPTORES PARALELOS + UMA TOMADA 10A	1"	12
	E017202153	LPC6-20 CB PVC CZ 2 T 20A 1 INT PARAL	DUAS TOMADAS 20A + UM INTERRUPTOR PARALELO	1"	12
	E017202154	LPC6-20 CB PVC CZ 2 INT PARAL 1 T 20A	DOIS INTERRUPTORES PARALELOS + UMA TOMADA 20A	1"	12

POLIWETZEL[®]

CAIXA DE DERIVAÇÃO MÓVEL

DISPENSA O USO DE PARAFUSOS
TAMPA COM ENCAIXE
RÁPIDO POR PRESSÃO

MULTI ENCAIXE
DIVERSAS COMBINAÇÕES
PARA CONEXÕES EM
ELETRODUTOS

ENCAIXE FUNCIONAL
FACILITA A DESMONTAGEM
E MANUTENÇÃO
DAS INSTALAÇÕES



CONHEÇA MAIS SOBRE

- DISPONÍVEL NAS BITOLAS 1/2", 3/4" E 1"

ALTURA DIFERENCIADA
GARANTE MAIS VOLUME INTERNO



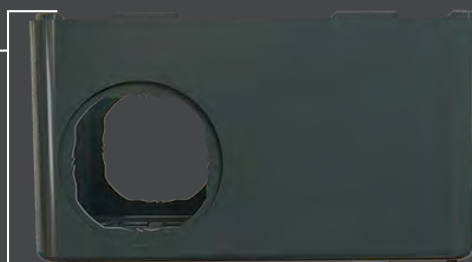



PRATICIDADE NA INSTALAÇÃO
E NA PASSAGEM DOS CABOS,
QUE EVITA O ESMAGAMENTO
E REDUZ RISCOS DE CURTOS
CIRCUITOS ELÉTRICOS.



PONTO DE APOIO
MANTÉM DISTÂNCIA DA
SUPERFÍCIE E EVITA O CONTATO
COM A UMIDADE.









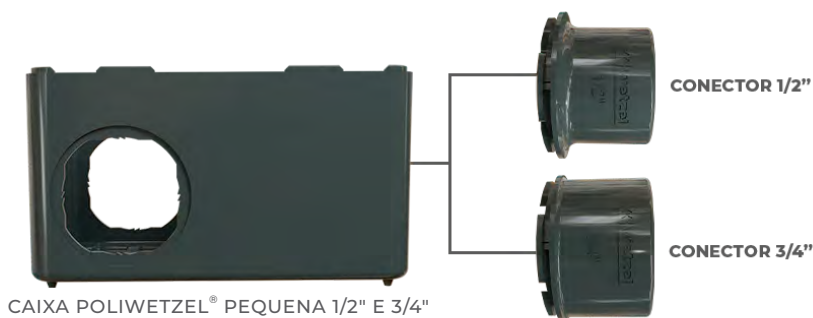

CAIXA DE DERIVAÇÃO MÓVEL PEQUENA E ACESSÓRIOS - 1/2" E 3/4"

	CÓDIGO	REFERÊNCIA	DESCRIÇÃO	BITOLA	QT. EMB.
	E017200020	LPC6-10/15 CORPO PVC CZ	CORPO E 4 TAMPÕES	1/2" e 3/4"	10
	E019600010	TPI-10/15 PVC CZ	TAMPÃO P/ POLIWETZEL PVC CINZA 1/2" E 3/4"	1/2" e 3/4"	50
	E020700010	CPCL-10 PVC CZ	CONECTOR P/ POLIWETZEL PVC CINZA 1/2"	1/2"	20
	E020700015	CPCL-15 PVC CZ	CONECTOR P/ POLIWETZEL PVC CINZA 3/4"	3/4"	20
	E020800010	UN-10/15 PVC CZ	UNIÃO P/ POLIWETZEL PVC CINZA 1/2" E 3/4"	1/2" e 3/4"	20
	E018000012	TPCC-10 /15 PVC CZ	TAMPA CEGA PVC CINZA 1/2" E 3/4"	1/2" e 3/4"	10
	E018002844	TPCM-55 PVC CZ	TAMPA MODULAR TRÊS POSTOS PVC CINZA 1/2" E 3/4"	1/2" e 3/4"	10

CONECTORES COMPATÍVEIS



CAIXA DE DERIVAÇÃO MÓVEL GRANDE E ACESSÓRIOS - 1/2", 3/4" E 1"

	CÓDIGO	REFERÊNCIA	DESCRIÇÃO	BITOLA	QT. EMB.
	E017200040	LPC6-20 CORPO PVC CZ	CORPO E 4 TAMPÕES	1"	10
	E019600020	TPI-20 PVC CZ	TAMPÃO P/ POLIWETZEL PVC CINZA 1"	1"	50
	E020700020	CPCL-20 PVC CZ	CONECTOR P/ POLIWETZEL PVC CINZA 1"	1"	20
	E020400010	CPCL-10 SU PVC CZ	CONECTOR SAÍDAS UNIFICADAS PVC CINZA 1/2" P/ POLIWETZEL 1"	1/2"	20
	E020400015	CPCL-15 SU PVC CZ	CONECTOR SAÍDAS UNIFICADAS PVC CINZA 3/4" P/ POLIWETZEL 1"	3/4"	20
	E020800020	UN-20 PVC CZ	UNIÃO P/ POLIWETZEL PVC CINZA 1"	1"	20
	E018000032	TPCC-20 PVC CZ	TAMPA CEGA PVC CINZA 1"	1"	10
	E018002854	TPCM-66 PVC CZ	TAMPA MODULAR TRÊS POSTOS PVC CINZA 1"	1"	10

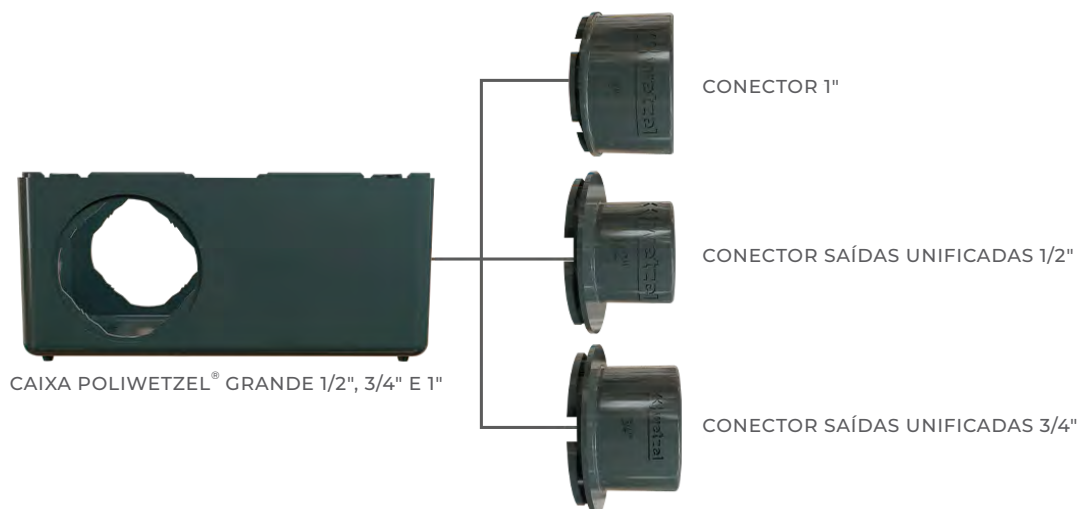

CONECTORES COMPATÍVEIS











A caixa múltipla grande (Poliwetzl®) de 1" é compatível com 3 bitolas, conforme o passo a passo na página 11.

TAMPAS PARA POLIWETZEL® PVC CINZA

*TAMPA MODULAR

	CÓDIGO	REFERÊNCIA	DESCRIÇÃO	BITOLA	QT. EMB.
	E018002844	TPCM-55 PVC CZ	TRÊS POSTOS	1/2" e 3/4"	10
	E018002854	TPCM-66 PVC CZ	TRÊS POSTOS	1"	10

TAMPA MODULAR | TOMADAS RJ

	CÓDIGO	REFERÊNCIA	DESCRIÇÃO	BITOLA	QT. EMB.
	E018002846	TPCM-55 PVC CZ + MÓDULO P/ RJ45	PARA UMA TOMADA RJ45	1/2" e 3/4"	10
	E018002847	TPCM-55 PVC CZ + 2 MÓDULOS P/RJ45	PARA DUAS TOMADAS RJ45	1/2" e 3/4"	10
	E018002848	TPCM-55 PVC CZ + RJ45 CAT 5E	COM UMA TOMADA RJ45 CAT 5E	1/2" e 3/4"	10
	E018002849	TPCM-55 PVC CZ + 2 RJ45 CAT 5E	COM DUAS TOMADAS RJ45 CAT 5E	1/2" e 3/4"	10
	E018002856	TPCM-66 PVC CZ + MÓDULO P/ RJ45	PARA UMA TOMADA RJ45	1"	10
	E018002857	TPCM-66 PVC CZ + 2 MÓDULOS P/RJ45	PARA DUAS TOMADAS RJ45	1"	10
	E018002858	TPCM-66 PVC CZ + RJ45 CAT 5E	COM UMA TOMADA RJ45 CAT 5E	1"	10
	E018002859	TPCM-66 PVC CZ + 2 RJ45 CAT 5E	COM DUAS TOMADAS RJ45 CAT 5E	1"	10

*As tampas modulares foram projetadas para acompanhar os módulos Wetzel da Linha Industrie.

LINHA INDUSTRIE MECANISMOS MODULARES



MÓDULOS WETZEL

ESPECIALMENTE DESENVOLVIDOS PARA AS TAMPAS MODULARES DE POLIWETZEL E CONDULETZEL.









Disponíveis nas páginas 137 e 138



TAMPA CEGA







	CÓDIGO	REFERÊNCIA	DESCRIÇÃO	BITOLA	QT. EMB.
	E018000012	TPCC-10 /15 PVC CZ	CEGA	1/2" e 3/4"	10
	E018000032	TPCC-20 PVC CZ	CEGA	1"	10

TAMPA MONOBLOCO

	CÓDIGO	REFERÊNCIA	DESCRIÇÃO	BITOLA	QT. EMB.
	E018000122	TPCA-01 PVC CZ	PARA UM INTERRUPTOR VERTICAL	1/2" e 3/4"	10
	E018000132	*TPCA-02 PVC CZ	PARA DOIS INTERRUPTORES HORIZONTAIS JUNTOS	1/2" e 3/4"	10
	E018000142	TPCA-03 PVC CZ	PARA TRÊS INTERRUPTORES HORIZONTAIS JUNTOS	1/2" e 3/4"	10
	E018000152	TPCA-04 PVC CZ	PARA DOIS INTERRUPTORES HORIZONTAIS SEPARADOS	1/2" e 3/4"	10
	E018000162	TPCA-05 PVC CZ	PARA UMA TOMADA REDONDA	1/2" e 3/4"	10
	E018002814	TPCA-35 PVC CZ	PARA UMA TOMADA HEXAGONAL VERTICAL	1/2" e 3/4"	10
	E018000282	TPCA-12 PVC CZ	PARA UM INTERRUPTOR VERTICAL	1"	10
	E018000292	*TPCA-13 PVC CZ	PARA DOIS INTERRUPTORES HORIZONTAIS JUNTOS	1"	10

TAMPAS PARA POLIWETZEL® PVC CINZA

TAMPA MONOBLOCO

	CÓDIGO	REFERÊNCIA	DESCRIÇÃO	BITOLA	QT. EMB.
	E018000302	TPCA-14 PVC CZ	PARA TRÊS INTERRUPTORES HORIZONTAIS JUNTOS	1"	10
	E018000312	TPCA-15 PVC CZ	PARA DOIS INTERRUPTORES HORIZONTAIS SEPARADOS	1"	10
	E018000013	TPCA-16 PVC CZ	PARA UMA TOMADA REDONDA	1"	10
	E018000014	TPCA-17 PVC CZ	PARA UMA TOMADA REDONDA	1"	10
	E018000402	TPCA-24 PVC CZ	PARA DUAS TOMADAS REDONDAS	1"	10
	E018002815	TPCA-36 PVC CZ	PARA DUAS TOMADAS HEXAGONAIS HORIZONTAIS SEPARADAS	1"	10
	E018002816	TPCA-37 PVC CZ	PARA UM INTERRUPTOR E UMA TOMADA HEXAGONAL HORIZONTAL SEPARADOS	1"	10
	E018002817	TPCA-38 PVC CZ	PARA DOIS INTERRUPTORES JUNTOS E UMA TOMADA HEXAGONAL HORIZONTAL SEPARADA	1"	10

MECANISMO MONOBLOCO (SOB CONSULTA)

	CÓDIGO	REFERÊNCIA	DESCRIÇÃO	COR	QT. EMB.
	E020900041	INT BI 10A/250V~	INTERRUPTOR BIPOLAR (SIMPLES/PARALELO) 10A-250V~	BRANCO	25

*COMPATÍVEL COM AS TAMPAS TPCA-02 E TPCA-13, PÁGINA 31.

CONDULETZEL[®]

CAIXA DE DERIVAÇÃO FIXA

ACOMPANHA PARAFUSOS
COM TRATAMENTO ESPECIAL

SEM ROSCA
CONEXÃO POR
MEIO DE ENCAIXE

CONHEÇA MAIS SOBRE

- DISPONÍVEL NAS BITOLAS 1/2", 3/4" E 1"
- DIVERSAS COMBINAÇÕES PARA CONEXÕES EM ELETRODUTOS

MODELOS DISPONÍVEIS:



C



E



LB



LL



LR



T



TB



X









CAIXA DE DERIVAÇÃO FIXA



	CÓDIGO	REFERÊNCIA	DESCRIÇÃO	TIPO	BITOLA	QT. EMB.
	E013020021	CCSR-10 CORPO PVC CZ	CAIXA FIXA CONDULETZEL CINZA TIPO C 1/2" S/ TP S/ VED S/ R	C	1/2"	5
	E013030021	ECSR-10 CORPO PVC CZ	CAIXA FIXA CONDULETZEL CINZA TIPO E 1/2" S/ TP S/ VED S/ R	E	1/2"	5
	E013040021	LBCSR-10 CORPO PVC CZ	CAIXA FIXA CONDULETZEL CINZA TIPO LB 1/2" S/ TP S/ VED S/ R	LB	1/2"	5
	E013050021	LLCSR-10 CORPO PVC CZ	CAIXA FIXA CONDULETZEL CINZA TIPO LL 1/2" S/ TP S/ VED S/ R	LL	1/2"	5
	E013060021	LRCSR-10 CORPO PVC CZ	CAIXA FIXA CONDULETZEL CINZA TIPO LR 1/2" S/ TP S/ VED S/ R	LR	1/2"	5
	E013070021	TCSR-10 CORPO PVC CZ	CAIXA FIXA CONDULETZEL CINZA TIPO T 1/2" S/ TP S/ VED S/ R	T	1/2"	5
	E013090021	TBCSR-10 CORPO PVC CZ	CAIXA FIXA CONDULETZEL CINZA TIPO TB 1/2" S/ TP S/ VED S/ R	TB	1/2"	5
	E013100021	XCSR-10 CORPO PVC CZ	CAIXA FIXA CONDULETZEL CINZA TIPO X 1/2" S/ TP S/ VED S/ R	X	1/2"	5
	E013020031	CCSR-15 CORPO PVC CZ	CAIXA FIXA CONDULETZEL CINZA TIPO C 3/4" S/ TP S/ VED S/ R	C	3/4"	5
	E013030031	ECSR-15 CORPO PVC CZ	CAIXA FIXA CONDULETZEL CINZA TIPO E 3/4" S/ TP S/ VED S/ R	E	3/4"	5
	E013040031	LBCSR-15 CORPO PVC CZ	CAIXA FIXA CONDULETZEL CINZA TIPO LB 3/4" S/ TP S/ VED S/ R	LB	3/4"	5
	E013050031	LLCSR-15 CORPO PVC CZ	CAIXA FIXA CONDULETZEL CINZA TIPO LL 3/4" S/ TP S/ VED S/ R	LL	3/4"	5
	E013060031	LRCSR-15 CORPO PVC CZ	CAIXA FIXA CONDULETZEL CINZA TIPO LR 3/4" S/ TP S/ VED S/ R	LR	3/4"	5
	E013070031	TCSR-15 CORPO PVC CZ	CAIXA FIXA CONDULETZEL CINZA TIPO T 3/4" S/ TP S/ VED S/ R	T	3/4"	5
	E013090031	TBCSR-15 CORPO PVC CZ	CAIXA FIXA CONDULETZEL CINZA TIPO TB 3/4" S/ TP S/ VED S/ R	TB	3/4"	5

TAMPAS PARA CONDULETZEL® PVC CINZA

CAIXA DE DERIVAÇÃO FIXA

	CÓDIGO	REFERÊNCIA	DESCRIÇÃO	TIPO	BITOLA	QT. EMB.
	E013100031	XCSR-15 CORPO PVC CZ	CAIXA FIXA CONDULETZEL CINZA TIPO X 3/4" S/ TP S/ VED S/ R	X	3/4"	5
	E013020041	CCSR-20 CORPO PVC CZ	CAIXA FIXA CONDULETZEL CINZA TIPO C 1" S/ TP S/ VED S/ R	C	1"	5
	E013030041	ECSR-20 CORPO PVC CZ	CAIXA FIXA CONDULETZEL CINZA TIPO E 1" S/ TP S/ VED S/ R	E	1"	5
	E013040041	LBCSR-20 CORPO PVC CZ	CAIXA FIXA CONDULETZEL CINZA TIPO LB 1" S/ TP S/ VED S/ R	LB	1"	5
	E013050041	LLCSR-20 CORPO PVC CZ	CAIXA FIXA CONDULETZEL CINZA TIPO LL 1" S/ TP S/ VED S/ R	LL	1"	5
	E013060041	LRCSR-20 CORPO PVC CZ	CAIXA FIXA CONDULETZEL CINZA TIPO LR 1" S/ TP S/ VED S/ R	LR	1"	5
	E013070041	TCSR-20 CORPO PVC CZ	CAIXA FIXA CONDULETZEL CINZA TIPO T 1" S/ TP S/ VED S/ R	T	1"	5
	E013090041	TBCSR-20 CORPO PVC CZ	CAIXA FIXA CONDULETZEL CINZA TIPO TB 1" S/ TP S/ VED S/ R	TB	1"	5
	E013100041	XCSR-20 CORPO PVC CZ	CAIXA FIXA CONDULETZEL CINZA TIPO X 1" S/ TP S/ VED S/ R	X	1"	5

*TAMPA MODULAR

	CÓDIGO	REFERÊNCIA	DESCRIÇÃO	BITOLA	QT. EMB.
	E014002844	TCCM-55 PVC CZ	TRÊS POSTOS	1/2" e 3/4"	10
	E014002854	TCCM-66 PVC CZ	TRÊS POSTOS	1"	10

TAMPA MODULAR | TOMADAS RJ

	CÓDIGO	REFERÊNCIA	DESCRIÇÃO	BITOLA	QT. EMB.
	E014002846	TCCM-55 PVC CZ + MÓDULO P/ RJ45	PARA UMA TOMADA RJ45	1/2" e 3/4"	10
	E014002847	TCCM-55 PVC CZ + 2 MÓDULOS P/ RJ45	PARA DUAS TOMADAS RJ45	1/2" e 3/4"	10

TAMPAS PARA CONDULETZEL® PVC CINZA

TAMPA MODULAR | TOMADAS RJ

	CÓDIGO	REFERÊNCIA	DESCRIÇÃO	BITOLA	QT. EMB.
	E014002848	TCCM-55 PVC CZ + RJ45 CAT 5E	COM UMA TOMADA RJ45 CAT 5E	1/2" e 3/4"	10
	E014002849	TCCM-55 PVC CZ + 2 RJ45 CAT 5E	COM DUAS TOMADAS RJ45 CAT 5E	1/2" e 3/4"	10
	E014002856	TCCM-66 PVC CZ + MÓDULO P/ RJ45	PARA UMA TOMADA RJ45	1"	10
	E014002857	TCCM-66 PVC CZ + 2 MÓDULOS P/RJ45	PARA DUAS TOMADAS RJ45	1"	10
	E014002858	TCCM-66 PVC CZ + RJ45 CAT 5E	COM UMA TOMADA RJ45 CAT 5E	1"	10
	E014002859	TCCM-66 PVC CZ + 2 RJ45 CAT 5E	COM DUAS TOMADAS RJ45 CAT 5E	1"	10

*As tampas modulares foram projetadas para acompanhar os módulos Wetzel da Linha Industrie.

LINHA INDUSTRIE MECANISMOS MODULARES



MÓDULOS WETZEL

ESPECIALMENTE DESENVOLVIDOS
PARA AS TAMPAS MODULARES DE
POLIWETZEL E CONDULETZEL.











Disponíveis nas páginas 137 e 138

TAMPA CEGA



	CÓDIGO	REFERÊNCIA	DESCRIÇÃO	BITOLA	QT. EMB.
	E014000012	TCCC-10/15 PVC CZ	CEGA	1/2" e 3/4"	10
	E014000032	TCCC-20 PVC CZ	CEGA	1"	10

TAMPA MONOBLOCO

	CÓDIGO	REFERÊNCIA	DESCRIÇÃO	BITOLA	QT. EMB.
	E014000122	TCCA-01 PVC CZ	PARA UM INTERRUPTOR VERTICAL	1/2" e 3/4"	10
	E014000132	*TCCA-02 PVC CZ	PARA DOIS INTERRUPTORES HORIZONTAIS JUNTOS	1/2" e 3/4"	10
	E014000142	TCCA-03 PVC CZ	PARA TRÊS INTERRUPTORES HORIZONTAIS JUNTOS	1/2" e 3/4"	10
	E014000152	TCCA-04 PVC CZ	PARA DOIS INTERRUPTORES HORIZONTAIS SEPARADOS	1/2" e 3/4"	10
	E014000162	TCCA-05 PVC CZ	PARA UMA TOMADA REDONDA	1/2" e 3/4"	10
	E014002814	TCCA-35 PVC CZ	PARA UMA TOMADA HEXAGONAL VERTICAL	1/2" e 3/4"	10
	E014000013	TCCA-16 PVC CZ	PARA UMA TOMADA REDONDA	1"	10
	E014000014	TCCA-17 PVC CZ	PARA UMA TOMADA REDONDA	1"	10
	E014000422	TCCA-24 PVC CZ	PARA DUAS TOMADAS REDONDAS	1"	10

TAMPAS PARA CONDULETZEL® PVC CINZA

TAMPA MONOBLOCO

	CÓDIGO	REFERÊNCIA	DESCRIÇÃO	BITOLA	QT. EMB.
	E014002820	TCCA-36 PVC CZ	PARA DUAS TOMADAS HEXAGONAIS HORIZONTAIS SEPARADAS	1"	10
	E014002830	TCCA-37 PVC CZ	PARA UM INTERRUPTOR E UMA TOMADA HEXAGONAL HORIZONTAL	1"	10
	E014002840	TCCA-38 PVC CZ	PARA DOIS INTERRUPTORES HORIZONTAIS JUNTOS E UMA TOMADA HEXAGONAL HORIZONTAL SEPARADA	1"	10

MECANISMO MONOBLOCO (SOB CONSULTA)

	CÓDIGO	REFERÊNCIA	DESCRIÇÃO	COR	QT. EMB.
	E020900041	INT BI 10A/250V~	INTERRUPTOR BIPOLAR (SIMPLES/PARALELO) 10A-250V~	BRANCO	25

*COMPATÍVEL COM A TAMPA TCCA-02, PÁGINA 37.

ELETRODUTOS, TUBOS E ACESSÓRIOS



CONHEÇA MAIS SOBRE

ELETRODUTOS

- ELETRODUTO **PLASTIK CLASSE A**
PAREDE EXTRA PARA AMBIENTES INDUSTRIAIS E/OU SUJEITOS À GRANDES SOLICITAÇÕES MECÂNICAS
- ELETRODUTO **PLASTIK PESADO**
SEGURANÇA PARA INSTALAÇÕES PESADAS EM AMBIENTES INDUSTRIAIS

TUBOS



- ELETROWETZEL **PLASTIK MAX**
VERSATILIDADE E CUSTO-BENEFÍCIO PARA AMBIENTES COMERCIAIS
- ELETROWETZEL **PLASTIK STANDARD**
QUALIDADE PARA AMBIENTES RESIDENCIAIS E/OU COM FINALIDADE DECORATIVA



ELETRODUTOS E TUBOS PVC CINZA

ELETRODUTOS

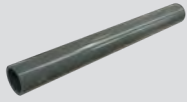
ELETRODUTO PLASTIK CLASSE A (SEM ROSCA)



	CÓDIGO	REFERÊNCIA	DESCRIÇÃO	ESPESSURA (mm)	BITOLA	QT. EMB.
	E020300315	EAC-15 PVC CZ	ELETRODUTO RÍGIDO CLASSE A PVC CINZA 3/4"	2,6	3/4"	20
	E020300320	EAC-20 PVC CZ	ELETRODUTO RÍGIDO CLASSE A PVC CINZA 1"	3,2	1	10

ELETRODUTO PLASTIK PESADO (SEM ROSCA)

	CÓDIGO	REFERÊNCIA	DESCRIÇÃO	ESPESSURA (mm)	BITOLA	QT. EMB.
	E020300010	EPC-10 PVC CZ	ELETRODUTO RÍGIDO PESADO PVC CINZA 1/2"	2	1/2"	20
	E020300015	EPC-15 PVC CZ	ELETRODUTO RÍGIDO PESADO PVC CINZA 3/4"	2,5	3/4"	20
	E020300020	EPC-20 PVC CZ	ELETRODUTO RÍGIDO PESADO PVC CINZA 1"	2,8	1	10
	E020300025	EPC-25 PVC CZ	ELETRODUTO RÍGIDO PESADO PVC CINZA 1.1/4"	2,9	1.1/4"	5
	E020300030	EPC-30 PVC CZ	ELETRODUTO RÍGIDO PESADO PVC CINZA 1.1/2"	3,0	1.1/2"	5
	E020300035	EPC-35 PVC CZ	ELETRODUTO RÍGIDO PESADO PVC CINZA 2"	3,1	2"	5

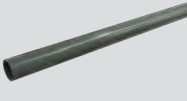

TUBOS

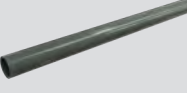
ELETROWETZEL PLASTIK MAX (SEM ROSCA)

	CÓDIGO	REFERÊNCIA	DESCRIÇÃO	ESPESSURA (mm)	BITOLA	QT. EMB.
	E020300210	EMC-10 PVC CZ	ELETROWETZEL RÍGIDO PLASTIK MAX PVC CINZA 1/2"	1,5	1/2"	20
	E020300215	EMC-15 PVC CZ	ELETROWETZEL RÍGIDO PLASTIK MAX PVC CINZA 3/4"	1,5	3/4"	20
	E020300220	EMC-20 PVC CZ	ELETROWETZEL RÍGIDO PLASTIK MAX PVC CINZA 1"	1,7	1	10

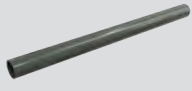

ELETROWETZEL PLASTIK STANDARD (SEM ROSCA)

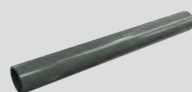
	CÓDIGO	REFERÊNCIA	DESCRIÇÃO	ESPESSURA (mm)	BITOLA	QT. EMB.
	E020300110	ESC-10 PVC CZ	ELETROWETZEL RÍGIDO PLASTIK STANDARD PVC CINZA 1/2"	1,2	1/2"	20
	E020300115	ESC-15 PVC CZ	ELETROWETZEL RÍGIDO PLASTIK STANDARD PVC CINZA 3/4"	1,2	3/4"	20
	E020300120	ESC-20 PVC CZ	ELETROWETZEL RÍGIDO PLASTIK STANDARD PVC CINZA 1"	1,4	1	10

ABRAÇADEIRA



	CÓDIGO	REFERÊNCIA	DESCRIÇÃO	BITOLA	QT. EMB.
	E015500010	ABC-10 PP CZ	ABRAÇADEIRA CINZA 1/2"	1/2"	50
	E015500015	ABC-15 PP CZ	ABRAÇADEIRA CINZA 3/4"	3/4"	50
	E015500020	ABC-20 PP CZ	ABRAÇADEIRA CINZA 1"	1"	50
	E015500025	ABC-25 PP CZ	ABRAÇADEIRA CINZA 1.1/4"	1.1/4"	20
	E015500030	ABC-30 PP CZ	ABRAÇADEIRA CINZA 1.1/2"	1.1/2"	20
	E015500035	ABC-35 PP CZ	ABRAÇADEIRA CINZA 2"	2"	20

LUVA (SEM ROSCA)

	CÓDIGO	REFERÊNCIA	DESCRIÇÃO	BITOLA	QT. EMB.
	E015200010	LC-10 PVC CZ	LUVA SEM ROSCA CINZA 1/2"	1/2"	20
	E015200015	LC-15 PVC CZ	LUVA SEM ROSCA CINZA 3/4"	3/4"	20
	E015200020	LC-20 PVC CZ	LUVA SEM ROSCA CINZA 1"	1"	20

ACESSÓRIOS PVC CINZA



BUCHA DE REDUÇÃO (SEM ROSCA)

	CÓDIGO	REFERÊNCIA	DESCRIÇÃO	BITOLA	QT. EMB.
	E015400010	BRC-15/10 PVC CZ	BUCHA DE REDUÇÃO SEM ROSCA CINZA 3/4x1/2"	3/4" X 1/2"	20
	E015400015	BRC-20/15 PVC CZ	BUCHA DE REDUÇÃO SEM ROSCA CINZA 1x3/4"	1" X 3/4"	20



APLICAÇÃO DE BUCHA DE REDUÇÃO EM CAIXA FIXA





CURVA 45° PLASTIK MAX (COM DUAS BOLSAS)

	CÓDIGO	REFERÊNCIA	DESCRIÇÃO	BITOLA	QT. EMB.
	E020600010	C45C-10 PVC CZ	CURVA 45° C/ 2 BOLSAS CINZA 1/2"	1/2"	10
	E020600015	C45C-15 PVC CZ	CURVA 45° C/ 2 BOLSAS CINZA 3/4"	3/4"	10
	E020600020	C45C-20 PVC CZ	CURVA 45° C/ 2 BOLSAS CINZA 1"	1"	10



CURVA 90° PLASTIK MAX (COM DUAS BOLSAS)

	CÓDIGO	REFERÊNCIA	DESCRIÇÃO	BITOLA	QT. EMB.
	E020100010	C90C-10 PVC CZ	CURVA 90° C/ 2 BOLSAS CINZA 1/2"	1/2"	10
	E020100015	C90C-15 PVC CZ	CURVA 90° C/ 2 BOLSAS CINZA 3/4"	3/4"	10
	E020100020	C90C-20 PVC CZ	CURVA 90° C/ 2 BOLSAS CINZA 1"	1"	10

CURVA 90° PLASTIK STANDARD (COM DUAS BOLSAS)

	CÓDIGO	REFERÊNCIA	DESCRIÇÃO	BITOLA	QT. EMB.
	E020101010	CS90C-10 PVC CZ	CURVA STANDARD 90° C/ 2 BOLSAS CINZA 1/2"	1/2"	10
	E020101015	CS90C-15 PVC CZ	CURVA STANDARD 90° C/ 2 BOLSAS CINZA 3/4"	3/4"	10
	E020101020	CS90C-20 PVC CZ	CURVA STANDARD 90° C/ 2 BOLSAS CINZA 1"	1"	10

COTOVELO 90° (COM TAMPA VIGIA SEM ROSCA)

	CÓDIGO	REFERÊNCIA	DESCRIÇÃO	BITOLA	QT. EMB.
	E015300010	CC-10 PVC CZ	COTOVELO C/ TAMPA VIGIA EM PVC SEM ROSCA CINZA 1/2"	1/2"	20
	E015300015	CC-15 PVC CZ	COTOVELO C/ TAMPA VIGIA EM PVC SEM ROSCA CINZA 3/4"	3/4"	20
	E015300020	CC-20 PVC CZ	COTOVELO C/ TAMPA VIGIA EM PVC SEM ROSCA CINZA 1"	1"	20

LINHA PRETO

Indicada para **salas comerciais, escritórios**, entre outros diversos locais. Com a finalidade decorativa, garante modernidade para o ambiente.



Não propaga
chamas



Não conduz
eletricidade



Praticidade
no encaixe



Apta para
reciclagem



COMBOS POLIWETZEL®

PÁGINAS
46 a 58

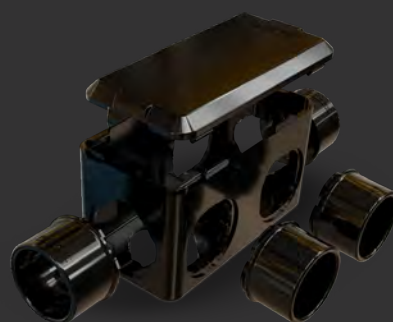

POLI WETZEL®

PÁGINAS
59 a 64

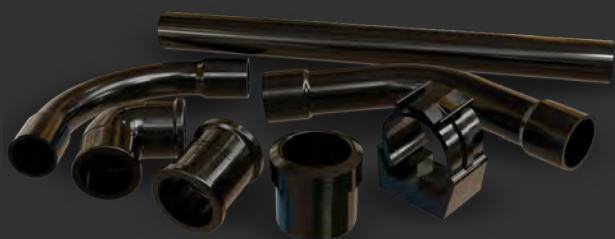

ELETRODUTOS, TUBOS E ACESSÓRIOS

PÁGINAS
66 a 69

COMBOS POLIWETZEL®

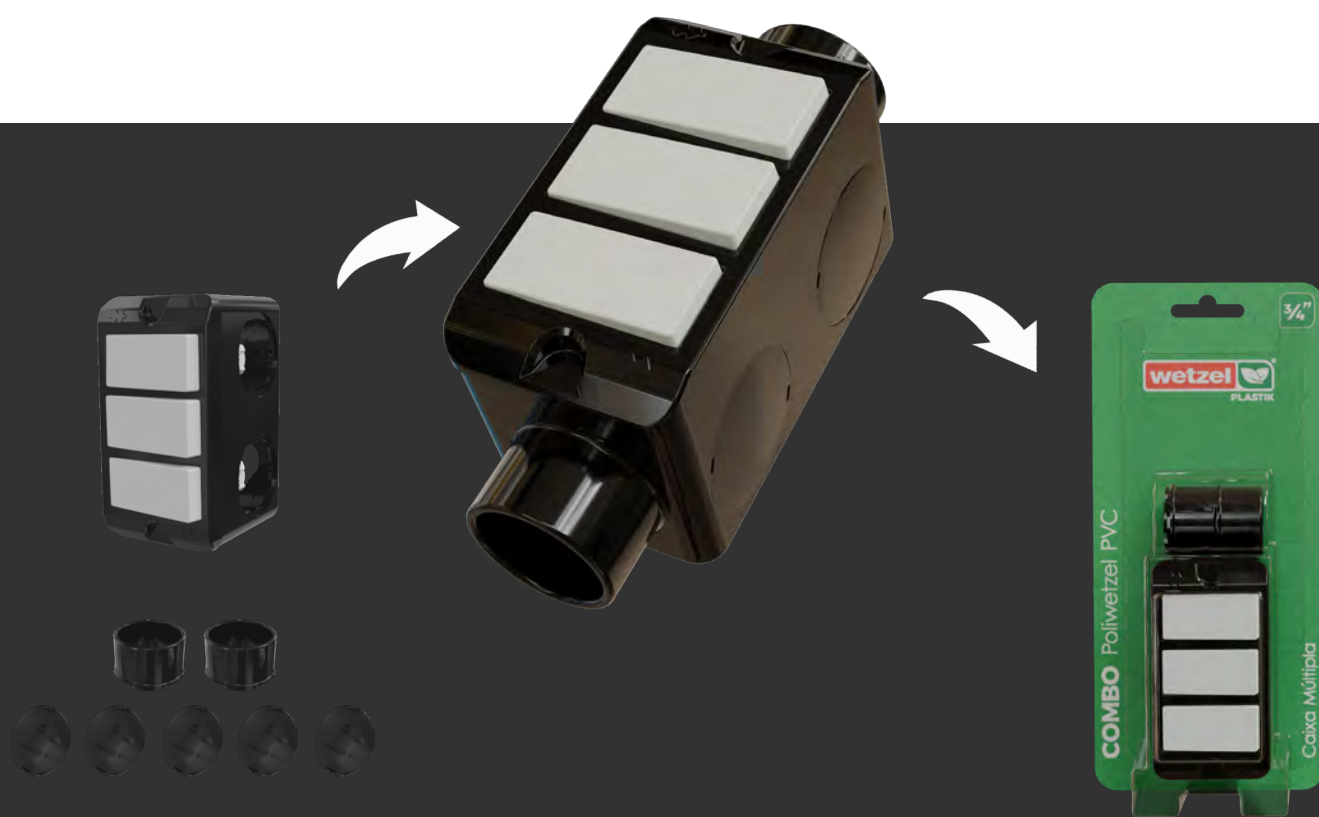

CONHEÇA OS COMBOS

- DISPONÍVEIS NAS BITOLAS 3/4" E 1"
- SOLUÇÕES COMPLETAS COM MECANISMOS MODULARES
- PRÁTICOS PARA ARMAZENAR E PREPARAR INSTALAÇÕES



COMBO POLIWETZEL®

CAIXA DE DERIVAÇÃO MÓVEL TIPO L COM 2 CONECTORES e 5 TAMPÕES

TAMPA CEGA

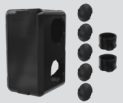
	CÓDIGO	REFERÊNCIA	DESCRIÇÃO	BITOLA	QT. EMB.
	E017232020	LPP6-15 CB PVC PR CEGO	TAMPA CEGA	3/4"	12

TAMPA MODULAR (SEM MECANISMO)

	CÓDIGO	REFERÊNCIA	DESCRIÇÃO	BITOLA	QT. EMB.
	E017232135	LPP6-15 CB PVC PR S/MÓDULO	TAMPA TRÊS POSTOS SEM MÓDULO	3/4"	12

COMBO POLIWETZEL®

CAIXA DE DERIVAÇÃO MÓVEL TIPO L COM 2 CONECTORES e 5 TAMPÕES

TAMPA MODULAR (COM 1 MECANISMO)

	CÓDIGO	REFERÊNCIA	DESCRIÇÃO	BITOLA	QT. EMB.
	E017232027	LPP6-15 CB PVC PR 1 T 10A	UMA TOMADA 10A	3/4"	12
	E017232028	LPP6-15 CB PVC PR 1 INT SIM	UM INTERRUPTOR SIMPLES	3/4"	12
	E017232032	LPP6-15 CB PVC PR 1 T 20A	UMA TOMADA 20A	3/4"	12
	E017232037	LPP6-15 CB PVC PR 1 RJ45 CAT 5E	UMA TOMADA RJ45 CAT 5E	3/4"	12
	E017232038	LPP6-15 CB PVC PR 1 RJ11	UMA TOMADA RJ11	3/4"	12
	E017232128	LPP6-15 CB PVC PR 1 INT PARAL	UM INTERRUPTOR PARALELO	3/4"	12
	E017232137	LPP6-15 CB PVC PR 1 RJ45 CAT 6	UMA TOMADA RJ45 CAT 6	3/4"	12
	E017232138	LPP6-15 CB PVC PR 1 USB 5.0V 2.0A	UMA TOMADA USB 5.0V 2.0A	3/4"	12

COMBO POLIWETZEL® PVC PRETO



COMBO POLIWETZEL®

CAIXA DE DERIVAÇÃO MÓVEL TIPO L COM 2 CONECTORES e 5 TAMPÕES













TAMPA MODULAR (COM 2 MECANISMOS)

	CÓDIGO	REFERÊNCIA	DESCRIÇÃO	BITOLA	QT. EMB.
	E017232023	LPP6-15 CB PVC PR 1 T 10A 1 INT SIM	UMA TOMADA 10A + UM INTERRUPTOR SIMPLES	3/4"	12
	E017232026	LPP6-15 CB PVC PR 1 RJ45 CAT 5E 1 RJ11	UMA TOMADA RJ45 CAT 5E + UMA TOMADA RJ11	3/4"	12
	E017232029	LPP6-15 CB PVC PR 2 T 10A	DUAS TOMADAS 10A	3/4"	12
	E017232030	LPP6-15 CB PVC PR 2 INT SIM	DOIS INTERRUPTORES SIMPLES	3/4"	12
	E017232031	LPP6-15 CB PVC PR 1 T 20A 1 INT SIM	UMA TOMADA 20A + UM INTERRUPTOR SIMPLES	3/4"	12
	E017232035	LPP6-15 CB PVC PR 2 T 20A	DUAS TOMADAS 20A	3/4"	12
	E017232036	LPP6-15 CB PVC PR 2 RJ45 CAT 5E	DUAS TOMADAS RJ45 CAT 5E	3/4"	12
	E017232123	LPP6-15 CB PVC PR 1 T 10A 1 INT PARAL	UMA TOMADA 10A + UM INTERRUPTOR PARALELO	3/4"	12
	E017232126	LPP6-15 CB PVC PR 1 RJ45 CAT 6 1 RJ11	UMA TOMADA RJ45 CAT 6 + UMA TOMADA RJ11	3/4"	12
	E017232130	LPP6-15 CB PVC PR 2 INT PARAL	DOIS INTERRUPTORES PARALELOS	3/4"	12
	E017232131	LPP6-15 CB PVC PR 1 T 20A 1 INT PARAL	UMA TOMADA 20A + UM INTERRUPTOR PARALELO	3/4"	12
	E017232136	LPP6-15 CB PVC PR 2 RJ45 CAT 6	DUAS TOMADAS RJ45 CAT 6	3/4"	12

COMBO POLIWETZEL®

CAIXA DE DERIVAÇÃO MÓVEL TIPO L COM 2 CONECTORES e 5 TAMPÕES

TAMPA MODULAR (COM 3 MECANISMOS)

	CÓDIGO	REFERÊNCIA	DESCRIÇÃO	BITOLA	QT. EMB.
	E017232021	LPP6-15 CB PVC PR 3 T 10A	TRÊS TOMADAS 10A	3/4"	12
	E017232022	LPP6-15 CB PVC PR 3 INT SIM	TRÊS INTERRUPTORES SIMPLES	3/4"	12
	E017232024	LPP6-15 CB PVC PR 2 T 10A 1 INT SIM	DUAS TOMADAS 10A + UM INTERRUPTOR SIMPLES	3/4"	12
	E017232025	LPP6-15 CB PVC PR 2 INT SIM 1 T 10A	DOIS INTERRUPTORES SIMPLES + UMA TOMADA 10A	3/4"	12
	E017232033	LPP6-15 CB PVC PR 2 T 20A 1 INT SIM	DUAS TOMADAS 20A + UM INTERRUPTOR SIMPLES	3/4"	12
	E017232034	LPP6-15 CB PVC PR 2 INT SIM 1 T 20A	DOIS INTERRUPTORES SIMPLES + UMA TOMADA 20A	3/4"	12
	E017232039	LPP6-15 CB PVC PR 3 T 20A	TRÊS TOMADAS 20A	3/4"	12
	E017232122	LPP6-15 CB PVC PR 3 INT PARAL	TRÊS INTERRUPTORES PARALELOS	3/4"	12
	E017232124	LPP6-15 CB PVC PR 2 T 10A 1 INT PARAL	DUAS TOMADAS 10A + UM INTERRUPTOR PARALELO	3/4"	12
	E017232125	LPP6-15 CB PVC PR 2 INT PARAL 1 T 10A	DOIS INTERRUPTORES PARALELOS + UMA TOMADA 10A	3/4"	12
	E017232133	LPP6-15 CB PVC PR 2 T 20A 1 INT PARAL	DUAS TOMADAS 20A + UM INTERRUPTOR PARALELO	3/4"	12
	E017232134	LPP6-15 CB PVC PR 2 INT PARAL 1 T 20A	DOIS INTERRUPTORES PARALELOS + UMA TOMADA 20A	3/4"	12

COMBO POLIWETZEL® PVC PRETO

COMBO POLIWETZEL®

CAIXA DE DERIVAÇÃO MÓVEL TIPO L COM 2 CONECTORES e 5 TAMPÕES

TAMPA CEGA

	CÓDIGO	REFERÊNCIA	DESCRIÇÃO	BITOLA	QT. EMB.
	E017232040	LPP6-20 CB PVC PR CEGO	TAMPA CEGA	1"	12

TAMPA MODULAR (SEM MECANISMO)

	CÓDIGO	REFERÊNCIA	DESCRIÇÃO	BITOLA	QT. EMB.
	E017232155	LPP6-20 CB PVC PR S/MÓDULO	TAMPA TRÊS POSTOS SEM MÓDULO	1"	12













TAMPA MODULAR (COM 1 MECANISMO)

	CÓDIGO	REFERÊNCIA	DESCRIÇÃO	BITOLA	QT. EMB.
	E017232047	LPP6-20 CB PVC PR 1 T 10A	UMA TOMADA 10A	1"	12
	E017232048	LPP6-20 CB PVC PR 1 INT SIM	UM INTERRUPTOR SIMPLES	1"	12
	E017232052	LPP6-20 CB PVC PR 1 T 20A	UMA TOMADA 20A	1"	12
	E017232057	LPP6-20 CB PVC PR 1 RJ45 CAT 5E	UMA TOMADA RJ45 CAT 5E	1"	12
	E017232058	LPP6-20 CB PVC PR 1 RJ11	UMA TOMADA RJ11	1"	12
	E017232148	LPP6-20 CB PVC PR 1 INT PARAL	UM INTERRUPTOR PARALELO	1"	12
	E017232157	LPP6-20 CB PVC PR 1 RJ45 CAT 6	UMA TOMADA RJ45 CAT 6	1"	12
	E017232158	LPP6-20 CB PVC PR 1 USB 5.0V 2.0A	UMA TOMADA USB 5.0V 2.0A	1"	12

COMBO POLIWETZEL®

CAIXA DE DERIVAÇÃO MÓVEL TIPO L COM 2 CONECTORES e 5 TAMPÕES

TAMPA MODULAR (COM 2 MECANISMOS)













	CÓDIGO	REFERÊNCIA	DESCRIÇÃO	BITOLA	QT. EMB.
	E017232043	LPP6-20 CB PVC PR 1 T 10A 1 INT SIM	UMA TOMADA 10A + UM INTERRUPTOR SIMPLES	1"	12
	E017232046	LPP6-20 CB PVC PR 1 RJ45 CAT 5E 1 RJ11	UMA TOMADA RJ45 CAT 5E + UMA TOMADA RJ11	1"	12
	E017232049	LPP6-20 CB PVC PR 2 T 10A	DUAS TOMADAS 10A	1"	12
	E017232050	LPP6-20 CB PVC PR 2 INT SIM	DOIS INTERRUPTORES SIMPLES	1"	12
	E017232051	LPP6-20 CB PVC PR 1 T 20A 1 INT SIM	UMA TOMADA 20A + UM INTERRUPTOR SIMPLES	1"	12
	E017232055	LPP6-20 CB PVC PR 2 T 20A	DUAS TOMADAS 20A	1"	12
	E017232056	LPP6-20 CB PVC PR 2 RJ45 CAT 5E	DUAS TOMADAS RJ45 CAT 5E	1"	12
	E017232143	LPP6-20 CB PVC PR 1 T 10A 1 INT PARAL	UMA TOMADA 10A + UM INTERRUPTOR PARALELO	1"	12
	E017232146	LPP6-20 CB PVC PR 1 RJ45 CAT 6, 1 RJ11	UMA TOMADA RJ45 CAT 6 + UMA TOMADA RJ11	1"	12
	E017232150	LPP6-20 CB PVC PR 2 INT PARAL	DOIS INTERRUPTORES PARALELOS	1"	12
	E017232151	LPP6-20 CB PVC PR 1 T 20A 1 INT PARAL	UMA TOMADA 20A + UM INTERRUPTOR PARALELO	1"	12
	E017232156	LPP6-20 CB PVC PR 2 RJ45 CAT 6	DUAS TOMADAS RJ45 CAT 6	1"	12

COMBO POLIWETZEL® PVC PRETO

COMBO POLIWETZEL®

CAIXA DE DERIVAÇÃO MÓVEL TIPO L COM 2 CONECTORES e 5 TAMPÕES

TAMPA MODULAR (COM 3 MECANISMOS)

	CÓDIGO	REFERÊNCIA	DESCRIÇÃO	BITOLA	QT. EMB.
	E017232041	LPP6-20 CB PVC PR 3 T 10A	TRÊS TOMADAS 10A	1"	12
	E017232042	LPP6-20 CB PVC PR 3 INT SIM	TRÊS INTERRUPTORES SIMPLES	1"	12
	E017232044	LPP6-20 CB PVC PR 2 T 10A 1 INT SIM	DUAS TOMADAS 10A + UM INTERRUPTOR SIMPLES	1"	12
	E017232045	LPP6-20 CB PVC PR 2 INT SIM 1 T 10A	DOIS INTERRUPTORES SIMPLES + UMA TOMADA 10A	1"	12
	E017232053	LPP6-20 CB PVC PR 2 T 20A 1 INT SIM	DUAS TOMADAS 20A + UM INTERRUPTOR SIMPLES	1"	12
	E017232054	LPP6-20 CB PVC PR 2 INT SIM 1 T 20A	DOIS INTERRUPTORES SIMPLES + UMA TOMADA 20A	1"	12
	E017232059	LPP6-20 CB PVC PR 3 T 20A	TRÊS TOMADAS 20A	1"	12
	E017232142	LPP6-20 CB PVC PR 3 INT PARAL	TRÊS INTERRUPTORES PARALELOS	1"	12
	E017232144	LPP6-20 CB PVC PR 2 T 10A 1 INT PARAL	DUAS TOMADAS 10A + UM INTERRUPTOR PARALELO	1"	12
	E017232145	LPP6-20 CB PVC PR 2 INT PARAL 1 T 10A	DOIS INTERRUPTORES PARALELOS + UMA TOMADA 10A	1"	12
	E017232153	LPP6-20 CB PVC PR 2 T 20A 1 INT PARAL	DUAS TOMADAS 20A + UM INTERRUPTOR PARALELO	1"	12
	E017232154	LPP6-20 CB PVC PR 2 INT PARAL 1 T 20A	DOIS INTERRUPTORES PARALELOS + UMA TOMADA 20A	1"	12

Conheça a nova linha de combos

All Black

LANÇAMENTO



Bitolas Disponíveis: 3/4" e 1"





COMBO POLIWETZEL® PVC

PRETO - AllBlack



COMBO POLIWETZEL® PVC - AllBlack

CAIXA DE DERIVAÇÃO MÓVEL TIPO L COM 2 CONECTORES e 5 TAMPÕES



COM 1 MECANISMO MODULAR

	CÓDIGO	REFERÊNCIA	DESCRIÇÃO	BITOLA	QT. EMB.
	E017242027	LPAB6-15 CB PVC AB 1 T 10A	UMA TOMADA 10A	3/4"	12
	E017242028	LPAB6-15 CB PVC AB 1 INT SIM	UM INTERRUPTOR SIMPLES	3/4"	12
	E017242032	LPAB6-15 CB PVC AB 1 T 20A	UMA TOMADA 20A	3/4"	12
	E017242037	LPAB6-15 CB PVC AB 1 RJ45 CAT 5E	UMA TOMADA RJ45 CAT 5E	3/4"	12
	E017242128	LPAB6-15 CB PVC AB 1 INT PARAL	UM INTERRUPTOR PARALELO	3/4"	12

COM 2 MECANISMOS MODULARES

	CÓDIGO	REFERÊNCIA	DESCRIÇÃO	BITOLA	QT. EMB.
	E017242023	LPAB6-15 CB PVC AB 1 T 10A 1 INT SIM	UMA TOMADA 10A + UM INTERRUPTOR SIMPLES	3/4"	12
	E017242029	LPAB6-15 CB PVC AB 2 T 10A	DUAS TOMADAS 10A	3/4"	12
	E017242030	LPAB6-15 CB PVC AB 2 INT SIM	DOIS INTERRUPTORES SIMPLES	3/4"	12
	E017242031	LPAB6-15 CB PVC AB 1 T 20A 1 INT SIM	UMA TOMADA 20A + UM INTERRUPTOR SIMPLES	3/4"	12
	E017242035	LPAB6-15 CB PVC AB 2 T 20A	DUAS TOMADAS 20A	3/4"	12
	E017242036	LPAB6-15 CB PVC AB 2 RJ45 CAT 5E	DUAS TOMADAS RJ45 CAT 5E	3/4"	12
	E017242123	LPAB6-15 CB PVC AB 1 T 10A 1 INT PARAL	UMA TOMADA 10A + UM INTERRUPTOR PARALELO	3/4"	12













COMBO POLIWETZEL® PVC PRETO - AllBlack

	E017242130	LPAB6-15 CB PVC AB 2 INT PARAL	DOIS INTERRUPTORES PARALELOS	3/4"	12
	E017242131	LPAB6-15 CB PVC AB 1 T 20A 1 INT PARAL	UMA TOMADA 20A + UM INTERRUPTOR PARALELO	3/4"	12

COMBO POLIWETZEL® PVC - AllBlack

CAIXA DE DERIVAÇÃO MÓVEL TIPO L COM 2 CONECTORES e 5 TAMPÕES

COM 3 MECANISMOS MODULARES

	CÓDIGO	REFERÊNCIA	DESCRIÇÃO	BITOLA	QT. EMB.
	E017242021	LPAB6-15 CB PVC AB 3 T 10A	TRÊS TOMADAS 10A	3/4"	12
	E017242022	LPAB6-15 CB PVC AB 3 INT SIM	TRÊS INTERRUPTORES SIMPLES	3/4"	12
	E017242024	LPAB6-15 CB PVC AB 2 T 10A 1 INT SIM	DUAS TOMADAS 10A + UM INTERRUPTOR SIMPLES	3/4"	12
	E017242025	LPAB6-15 CB PVC AB 2 INT SIM 1 T 10A	DOIS INTERRUPTORES SIMPLES + UMA TOMADA 10A	3/4"	12
	E017242033	LPAB6-15 CB PVC AB 2 T 20A 1 INT SIM	DUAS TOMADAS 20A + UM INTERRUPTOR SIMPLES	3/4"	12
	E017242034	LPAB6-15 CB PVC AB 2 INT SIM 1 T 20A	DOIS INTERRUPTORES SIMPLES + UMA TOMADA 20A	3/4"	12
	E017242039	LPAB6-15 CB PVC AB 3 T 20A	TRÊS TOMADAS 20A	3/4"	12
	E017242122	LPAB6-15 CB PVC AB 3 INT PARAL	TRÊS INTERRUPTORES PARALELOS	3/4"	12
	E017242124	LPAB6-15 CB PVC AB 2 T 10A 1 INT PARAL	DUAS TOMADAS 10A + UM INTERRUPTOR PARALELO	3/4"	12
	E017242125	LPAB6-15 CB PVC AB 2 INT PARAL 1 T 10A	DOIS INTERRUPTORES PARALELOS + UMA TOMADA 10A	3/4"	12
	E017242133	LPAB6-15 CB PVC AB 2 T 20A 1 INT PARAL	DUAS TOMADAS 20A + UM INTERRUPTOR PARALELO	3/4"	12
	E017242134	LPAB6-15 CB PVC AB 2 INT PARAL 1 T 20A	DOIS INTERRUPTORES PARALELOS + UMA TOMADA 20A	3/4"	12





COMBO POLIWETZEL® PVC

PRETO - AllBlack

COMBO POLIWETZEL® PVC - AllBlack

CAIXA DE DERIVAÇÃO MÓVEL TIPO L COM 2 CONECTORES e 5 TAMPÕES

COM 1 MECANISMO MODULAR



	CÓDIGO	REFERÊNCIA	DESCRIÇÃO	BITOLA	QT. EMB.
	E017242047	LPAB6-20 CB PVC AB 1 T 10A	UMA TOMADA 10A	1"	12
	E017242048	LPAB6-20 CB PVC AB 1 INT SIM	UM INTERRUPTOR SIMPLES	1"	12
	E017242052	LPAB6-20 CB PVC AB 1 T 20A	UMA TOMADA 20A	1"	12
	E017242057	LPAB6-20 CB PVC AB 1 RJ45 CAT 5E	UMA TOMADA RJ45 CAT 5E	1"	12
	E017242148	LPAB6-20 CB PVC AB 1 INT PARAL	UM INTERRUPTOR PARALELO	1"	12

COM 2 MECANISMOS MODULARES

	CÓDIGO	REFERÊNCIA	DESCRIÇÃO	BITOLA	QT. EMB.
	E017242043	LPAB6-20 CB PVC AB 1 T 10A 1 INT SIM	UMA TOMADA 10A + UM INTERRUPTOR SIMPLES	1"	12
	E017242049	LPAB6-20 CB PVC AB 2 T 10A	DUAS TOMADAS 10A	1"	12
	E017242050	LPAB6-20 CB PVC AB 2 INT SIM	DOIS INTERRUPTORES SIMPLES	1"	12
	E017242051	LPAB6-20 CB PVC AB 1 T 20A 1 INT SIM	UMA TOMADA 20A + UM INTERRUPTOR SIMPLES	1"	12
	E017242055	LPAB6-20 CB PVC AB 2 T 10A	DUAS TOMADAS 20A	1"	12
	E017242143	LPAB6-20 CB PVC AB 1 T 10A 1 INT PARAL	UMA TOMADA 10A + UM INTERRUPTOR PARALELO	1"	12
	E017242056	LPAB6-20 CB PVC AB 2 RJ45 CAT 5E	DUAS TOMADAS RJ45 CAT 5E	1"	12

COMBO POLIWETZEL® PVC













PRETO - AllBlack

	E017242150	LPAB6-20 CB PVC AB 2 INT PARAL	DOIS INTERRUPTORES PARALELOS	1"	12
	E017242151	LPAB6-20 CB PVC AB 1 T 20A 1 INT PARAL	UMA TOMADA 20A + UM INTERRUPTOR PARALELO	1"	12

COMBO POLIWETZEL® PVC - AllBlack

CAIXA DE DERIVAÇÃO MÓVEL TIPO L COM 2 CONECTORES e 5 TAMPÕES

COM 3 MECANISMOS MODULARES

	CÓDIGO	REFERÊNCIA	DESCRIÇÃO	BITOLA	QT. EMB.
	E017242041	LPAB6-20 CB PVC AB 3 T 10A	TRÊS TOMADAS 10A	1"	12
	E017242042	LPAB6-20 CB PVC AB 3 INT SIM	TRÊS INTERRUPTORES SIMPLES	1"	12
	E017242044	LPAB6-20 CB PVC AB 2 T 10A 1 INT SIM	DUAS TOMADAS 10A + UM INTERRUPTOR SIMPLES	1"	12
	E017242045	LPAB6-20 CB PVC AB 2 INT SIM 1 T 10A	DOIS INTERRUPTORES SIMPLES + UMA TOMADA 10A	1"	12
	E017242053	LPAB6-20 CB PVC AB 2 T 20A 1 INT SIM	DUAS TOMADAS 20A + UM INTERRUPTOR SIMPLES	1"	12
	E017242054	LPAB6-20 CB PVC AB 2 INT SIM 1 T 20A	DOIS INTERRUPTORES SIMPLES + UMA TOMADA 20A	1"	12
	E017242059	LPAB6-20 CB PVC AB 3 T 20A	TRÊS TOMADAS 20A	1"	12
	E017242142	LPAB6-20 CB PVC AB 3 INT PARAL	TRÊS INTERRUPTORES PARALELOS	1"	12
	E017242144	LPAB6-20 CB PVC AB 2 T 10A 1 INT PARAL	DUAS TOMADAS 10A + UM INTERRUPTOR PARALELO	1"	12
	E017242145	LPAB6-20 CB PVC AB 2 INT PARAL 1 T 10A	DOIS INTERRUPTORES PARALELOS + UMA TOMADA 10A	1"	12
	E017242153	LPAB6-20 CB PVC AB 2 T 20A 1 INT PARAL	DUAS TOMADAS 20A + UM INTERRUPTOR PARALELO	1"	12
	E017242154	LPAB6-20 CB PVC AB 2 INT PARAL 1 T 20A	DOIS INTERRUPTORES PARALELOS + UMA TOMADA 20A	1"	12

COMBOS POLIWETZEL®



Linha Preto **All Black**

A ELEGÂNCIA ENCONTRA A ROBUSTEZ

Oferece uma estética sofisticada e moderna, com módulos industrie na cor preta. Garante uma solução robusta e elegante para o seu ambiente.

Linha **Preto**

MONTE A SOLUÇÃO PERFEITA

Conta com módulos industrie versáteis que se adaptam a diferentes ambientes residenciais e comerciais.



POLIWETZEL®

CAIXA DE DERIVAÇÃO MÓVEL

DISPENSA O USO DE PARAFUSOS

TAMPA COM ENCAIXE RÁPIDO POR PRESSÃO

MULTI ENCAIXE

DIVERSAS COMBINAÇÕES PARA CONEXÕES EM ELETRODUTOS

ENCAIXE FUNCIONAL

FACILITA A DESMONTAGEM E MANUTENÇÃO DAS INSTALAÇÕES



CONHEÇA MAIS SOBRE

- DISPONÍVEL NAS BITOLAS 1/2", 3/4" E 1"

ALTURA DIFERENCIADA

GARANTE MAIS VOLUME INTERNO

PRATICIDADE NA INSTALAÇÃO E NA PASSAGEM DOS CABOS, QUE EVITA O ESMAGAMENTO E REDUZ RISCOS DE CURTOS CIRCUITOS ELÉTRICOS.



PONTO DE APOIO

MANTÉM DISTÂNCIA DA SUPERFÍCIE E EVITA O CONTATO COM A UMIDADE.



CAIXA DE DERIVAÇÃO MÓVEL PEQUENA E ACESSÓRIOS - 1/2" E 3/4"

	CÓDIGO	REFERÊNCIA	DESCRIÇÃO	BITOLA	QT. EMB.
	E017230020	LPP6-10/15 CORPO PVC PR	CORPO E 4 TAMPÕES	1/2" e 3/4"	10
	E019620010	TPIP-10/15 PVC PR	TAMPÃO PARA POLIWETZEL PVC PRETO 1/2" E 3/4"	1/2" e 3/4"	50
	E020720010	CPPL-10 PVC PR	CONECTOR P/ POLIWETZEL PVC PRETO 1/2"	1/2"	20
	E020720015	CPPL-15 PVC PR	CONECTOR P/ POLIWETZEL PVC PRETO 3/4"	3/4"	20
	E018020012	TPPC-10/15 PVC PR	TAMPA CEGA PVC PRETO 1/2" E 3/4"	1/2" e 3/4"	10
	E018022884	TPPM-55 PVC PR	TAMPA MODULAR TRÊS POSTOS PVC PRETO 1/2" E 3/4"	1/2" e 3/4"	10

CONECTORES COMPATÍVEIS

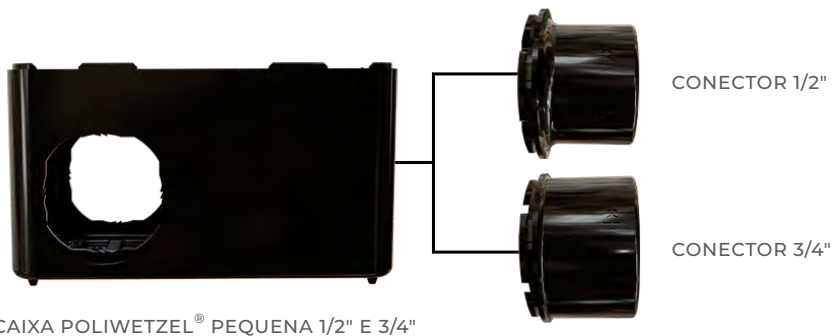

CAIXA DE DERIVAÇÃO MÓVEL GRANDE E ACESSÓRIOS - 1/2", 3/4" E 1"

	CÓDIGO	REFERÊNCIA	DESCRIÇÃO	BITOLA	QT. EMB.
	E017230040	LPP6-20 CORPO PVC PR	CORPO E 4 TAMPÕES	1"	10
	E019620020	TPIP-20 PVC PR	TAMPÃO PARA POLIWETZEL PVC PRETO 1"	1"	50
	E020720020	CPPL-20 PVC PR	CONECTOR P/ POLIWETZEL PVC PRETO 1"	1"	20
	E020420010	CPPL-10 SU PVC PR	CONCETOR SAÍDAS UNIFICADAS PVC PRETO 1/2" P/ POLIWETZEL 1"	1/2"	20
	E020420015	CPPL-15 SU PVC PR	CONCETOR SAÍDAS UNIFICADAS PVC PRETO 3/4" P/ POLIWETZEL 1"	3/4"	20
	E018020032	TPPC-20 PVC PR	TAMPA CEGA PVC PRETO 1"	1"	10
	E018022854	TPPM-66 PVC PR	TAMPA MODULAR TRÊS POSTOS PVC PRETO 1"	1"	10

CONECTORES COMPATÍVEIS

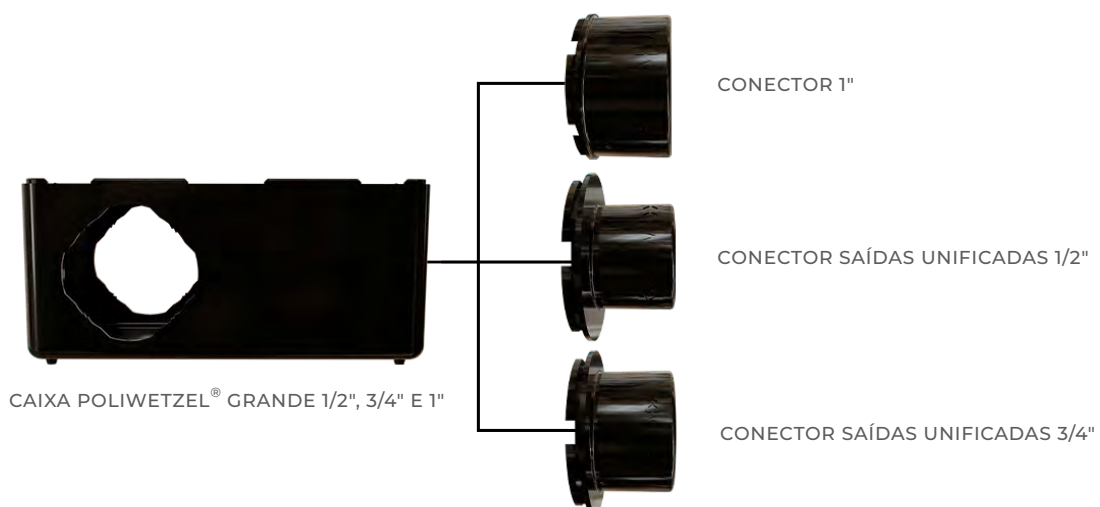









A caixa múltipla grande (Poliwetzel®) de 1" é compatível com 3 bitolas, conforme o passo a passo na página 11.

TAMPAS PARA POLIWETZEL® PVC PRETO

*TAMPA MODULAR

	CÓDIGO	REFERÊNCIA	DESCRIÇÃO	BITOLA	QT. EMB.
	E018022884	TPPM-55 PVC PR	TRÊS POSTOS	1/2" e 3/4"	10
	E018022854	TPPM-66 PVC PR	TRÊS POSTOS	1"	10

TAMPA MODULAR | TOMADAS RJ

	CÓDIGO	REFERÊNCIA	DESCRIÇÃO	BITOLA	QT. EMB.
	E018022846	TPPM-55 PVC PR + MÓDULO P/ RJ45	PARA UMA TOMADA RJ45	1/2" e 3/4"	10
	E018022847	TPPM-55 PVC PR + 2 MÓDULOS P/ RJ45	PARA DUAS TOMADAS RJ45	1/2" e 3/4"	10
	E018022848	TPPM-55 PVC PR + RJ45 CAT 5E	COM UMA TOMADA RJ45 CAT 5E	1/2" e 3/4"	10
	E018022849	TPPM-55 PVC PR + 2 RJ45 CAT 5E	COM DUAS TOMADAS RJ45 CAT 5E	1/2" e 3/4"	10
	E018022856	TPPM-66 PVC PR + MÓDULO P/ RJ45	PARA UMA TOMADA RJ45	1"	10
	E018022857	TPPM-66 PVC PR + 2 MÓDULOS P/ RJ45	PARA DUAS TOMADAS RJ45	1"	10
	E018022858	TPPM-66 PVC PR + RJ45 CAT 5E	COM UMA TOMADA RJ45 CAT 5E	1"	10
	E018022859	TPPM-66 PVC PR + 2 RJ45 CAT 5E	COM DUAS TOMADAS RJ45 CAT 5E	1"	10

*As tampas modulares foram projetadas para acompanhar os módulos Wetzel da Linha Industrie.



LINHA INDUSTRIE MECANISMOS MODULARES

MÓDULOS WETZEL
ESPECIALMENTE DESENVOLVIDOS PARA AS TAMPAS
MODULARES DE POLIWETZEL.









Disponíveis nas páginas 137 e 138



TAMPA CEGA





	CÓDIGO	REFERÊNCIA	DESCRIÇÃO	BITOLA	QT. EMB.
	E018020012	TPPC-10/15 PVC PR	CEGA	1/2" e 3/4"	10
	E018020032	TPPC-20 PVC PR	CEGA	1"	10

TAMPA MONOBLOCO

	CÓDIGO	REFERÊNCIA	DESCRIÇÃO	BITOLA	QT. EMB.
	E018020122	TPPA-01 PVC PR	PARA UM INTERRUPTOR VERTICAL	1/2" e 3/4"	10
	E018020132	*TPPA-02 PVC PR	PARA DOIS INTERRUPTORES HORIZONTAIS JUNTOS	1/2" e 3/4"	10
	E018020142	TPPA-03 PVC PR	PARA TRÊS INTERRUPTORES HORIZONTAIS JUNTOS	1/2" e 3/4"	10
	E018020152	TPPA-04 PVC PR	PARA DOIS INTERRUPTORES HORIZONTAIS SEPARADOS	1/2" e 3/4"	10
	E018020162	TPPA-05 PVC PR	PARA UMA TOMADA REDONDA	1/2" e 3/4"	10
	E018022814	TPPA-35 PVC PR	PARA UMA TOMADA HEXAGONAL VERTICAL	1/2" e 3/4"	10
	E018020282	TPPA-12 PVC PR	PARA UM INTERRUPTOR VERTICAL	1"	10
	E018020292	*TPPA-13 PVC PR	PARA DOIS INTERRUPTORES HORIZONTAIS JUNTOS	1"	10

TAMPAS PARA POLIWETZEL® PVC PRETO

TAMPA MONOBLOCO

	CÓDIGO	REFERÊNCIA	DESCRIÇÃO	BITOLA	QT. EMB.
	E018020302	TPPA-14 PVC PR	PARA TRÊS INTERRUPTORES HORIZONTAIS JUNTOS	1"	10
	E018020312	TPPA-15 PVC PR	PARA DOIS INTERRUPTORES HORIZONTAIS SEPARADOS	1"	10
	E018020013	TPPA-16 PVC PR	PARA UMA TOMADA REDONDA	1"	10
	E018020014	TPPA-17 PVC PR	PARA UMA TOMADA REDONDA	1"	10
	E018020402	TPPA-24 PVC PR	PARA DUAS TOMADAS REDONDAS	1"	10
	E018022815	TPPA-36 PVC PR	PARA DUAS TOMADAS HEXAGONAIS HORIZONTAIS SEPARADAS	1"	10
	E018022816	TPPA-37 PVC PR	PARA UM INTERRUPTOR + UMA TOMADA HEXAGONAL HORIZONTAL	1"	10
	E018022817	TPPA-38 PVC PR	PARA DOIS INTERRUPTORES + UMA TOMADA HEXAGONAL HORIZONTAL	1"	10

MECANISMO MONOBLOCO (SOB CONSULTA)

	CÓDIGO	REFERÊNCIA	DESCRIÇÃO	COR	QT. EMB.
	E020900041	INT BI 10A/250V~	INTERRUPTOR BIPOLAR (SIMPLES/PARALELO) 10A-250V~	BRANCO	25

*COMPATÍVEL COM AS TAMPAS TPPA-02 E TPPA-13, PÁGINA 63.

CONHEÇA NOSSA LINHA **POLIWETZEL**



ACESSE E BAIXE



www.WETZEL.com.br



ELETRODUTOS, TUBOS E ACESSÓRIOS



CONHEÇA MAIS SOBRE

ELETRODUTOS

- **ELETRODUTO PLASTIK PESADO**
SEGURANÇA PARA INSTALAÇÕES PROFISSIONAIS EM AMBIENTES INDUSTRIAIS

TUBOS

- **ELETROWETZEL PLASTIK MAX**
VERSATILIDADE E CUSTO-BENEFÍCIO PARA AMBIENTES COMERCIAIS
- **ELETROWETZEL PLASTIK STANDARD**
QUALIDADE PARA AMBIENTES RESIDENCIAIS E/OU COM FINALIDADE DECORATIVA



ELETRODUTOS

ELETRODUTO PLASTIK PESADO (SEM ROSCA)



	CÓDIGO	REFERÊNCIA	DESCRIÇÃO	ESPESSURA (mm)	BITOLA	QT. EMB.
	E020320010	EPP-10 PVC PR	ELETRODUTO RÍGIDO PESADO PVC PRETO 1/2"	2	1/2"	20
	E020320015	EPP-15 PVC PR	ELETRODUTO RÍGIDO PESADO PVC PRETO 3/4"	2,5	3/4"	20
	E020320020	EPP-20 PVC PR	ELETRODUTO RÍGIDO PESADO PVC PRETO 1"	2,8	1"	10

TUBOS

ELETROWETZEL PLASTIK MAX (SEM ROSCA)

	CÓDIGO	REFERÊNCIA	DESCRIÇÃO	ESPESSURA (mm)	BITOLA	QT. EMB.
	E020320210	EMP-10 PVC PR	ELETROWETZEL RÍGIDO PLASTIK MAX PVC PRETO 1/2"	1,5	1/2"	20
	E020320215	EMP-15 PVC PR	ELETROWETZEL RÍGIDO PLASTIK MAX PVC PRETO 3/4"	1,5	3/4"	20
	E020320220	EMP-20 PVC PR	ELETROWETZEL RÍGIDO PLASTIK MAX PVC PRETO 1"	1,7	1"	10

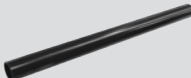
ELETROWETZEL PLASTIK STANDARD (SEM ROSCA)

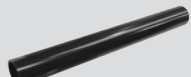
	CÓDIGO	REFERÊNCIA	DESCRIÇÃO	ESPESSURA (mm)	BITOLA	QT. EMB.
	E020320110	ESP-10 PVC PR	ELETROWETZEL RÍGIDO PLASTIK STANDARD PVC PRETO 1/2"	1,2	1/2"	20
	E020320115	ESP-15 PVC PR	ELETROWETZEL RÍGIDO PLASTIK STANDARD PVC PRETO 3/4"	1,2	3/4"	20
	E020320120	ESP-20 PVC PR	ELETROWETZEL RÍGIDO PLASTIK STANDARD PVC PRETO 1"	1,4	1"	10

ACESSÓRIOS PVC

PRETO



ABRAÇADEIRA

	CÓDIGO	REFERÊNCIA	DESCRIÇÃO	BITOLA	QT. EMB.
	E015520010	ABP-10 PP PR	ABRAÇADEIRA PRETA 1/2"	1/2"	50
	E015520015	ABP-15 PP PR	ABRAÇADEIRA PRETA 3/4"	3/4"	50
	E015520020	ABP-20 PP PR	ABRAÇADEIRA PRETA 1"	1"	50
	E015520025	ABP-25 PP PR	ABRAÇADEIRA PRETA 1.1/4"	1.1/4"	20
	E015520030	ABP-30 PP PR	ABRAÇADEIRA PRETA 1.1/2"	1.1/2"	20
	E015520035	ABP-35 PP PR	ABRAÇADEIRA PRETA 2"	2"	20

LUVA (SEM ROSCA)

	CÓDIGO	REFERÊNCIA	DESCRIÇÃO	BITOLA	QT. EMB.
	E015220010	LP-10 PVC PR	LUVA SEM ROSCA PRETA 1/2"	1/2"	20
	E015220015	LP-15 PVC PR	LUVA SEM ROSCA PRETA 3/4"	3/4"	20
	E015220020	LP-20 PVC PR	LUVA SEM ROSCA PRETA 1"	1"	20



BUCHA DE REDUÇÃO (SEM ROSCA)

	CÓDIGO	REFERÊNCIA	DESCRIÇÃO	BITOLA	QT. EMB.
	E015420010	BRP-15/10 PVC PR	BUCHA DE REDUÇÃO SEM ROSCA PRETA 3/4"x1/2"	3/4" X 1/2"	20
	E015420015	BRP-20/15 PVC PR	BUCHA DE REDUÇÃO SEM ROSCA PRETA 1"x3/4"	1" X 3/4"	20



APLICAÇÃO DE BUCHA DE REDUÇÃO EM CAIXA FIXA





CURVA 45° PLASTIK MAX (COM DUAS BOLSAS)

	CÓDIGO	REFERÊNCIA	DESCRIÇÃO	BITOLA	QT. EMB.
	E020620010	C45P-10 PVC PR	CURVA 45° C/ 2 BOLSAS PRETA 1/2"	1/2"	10
	E020620015	C45P-15 PVC PR	CURVA 45° C/ 2 BOLSAS PRETA 3/4"	3/4"	10
	E020620020	C45P-20 PVC PR	CURVA 45° C/ 2 BOLSAS PRETA 1"	1"	10



CURVA 90° PLASTIK MAX (COM DUAS BOLSAS)

	CÓDIGO	REFERÊNCIA	DESCRIÇÃO	BITOLA	QT. EMB.
	E020120010	C90P-10 PVC PR	CURVA 90° C/ 2 BOLSAS PRETA 1/2"	1/2"	10
	E020120015	C90P-15 PVC PR	CURVA 90° C/ 2 BOLSAS PRETA 3/4"	3/4"	10
	E020120020	C90P-20 PVC PR	CURVA 90° C/ 2 BOLSAS PRETA 1"	1"	10

CURVA 90° PLASTIK STANDARD (COM DUAS BOLSAS)

	CÓDIGO	REFERÊNCIA	DESCRIÇÃO	BITOLA	QT. EMB.
	E020121010	CS90P-10 PVC PR	CURVA STANDARD 90° C/ 2 BOLSAS PRETA 1/2"	1/2"	10
	E020121015	CS90P-15 PVC PR	CURVA STANDARD 90° C/ 2 BOLSAS PRETA 3/4"	3/4"	10
	E020121020	CS90P-20 PVC PR	CURVA STANDARD 90° C/ 2 BOLSAS PRETA 1"	1"	10

COTOVELO 90° (COM TAMPA VIGIA SEM ROSCA)

	CÓDIGO	REFERÊNCIA	DESCRIÇÃO	BITOLA	QT. EMB.
	E015320010	CP-10 PVC PR	COTOVELO C/ TAMPA VIGIA EM PVC SEM ROSCA PRETO 1/2"	1/2"	20
	E015320015	CP-15 PVC PR	COTOVELO C/ TAMPA VIGIA EM PVC SEM ROSCA PRETO 3/4"	3/4"	20
	E015320020	CP-20 PVC PR	COTOVELO C/ TAMPA VIGIA EM PVC SEM ROSCA PRETO 1"	1"	20

LINHA BRANCO

Indicada para uso em **ambientes hospitalares e alimentícios**, devido aos rigorosos padrões de segurança e desempenho necessários.



Não propaga
chamas



Não conduz
eletricidade



Praticidade
no encaixe



Apta para
reciclagem



COMBOS POLIWETZEL®

PÁGINAS
72 a 78



POLI WETZEL®

PÁGINAS
79 a 84



CONDULETZEL®

PÁGINAS
86 a 91

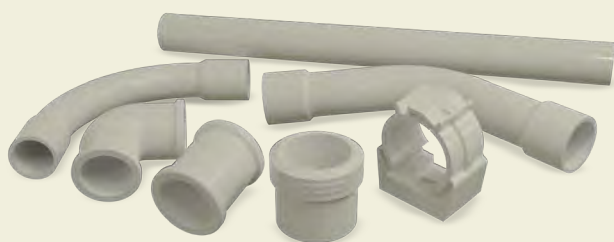

ELETRODUTOS, TUBOS E ACESSÓRIOS

PÁGINAS
92 a 96

COMBOS POLIWETZEL®

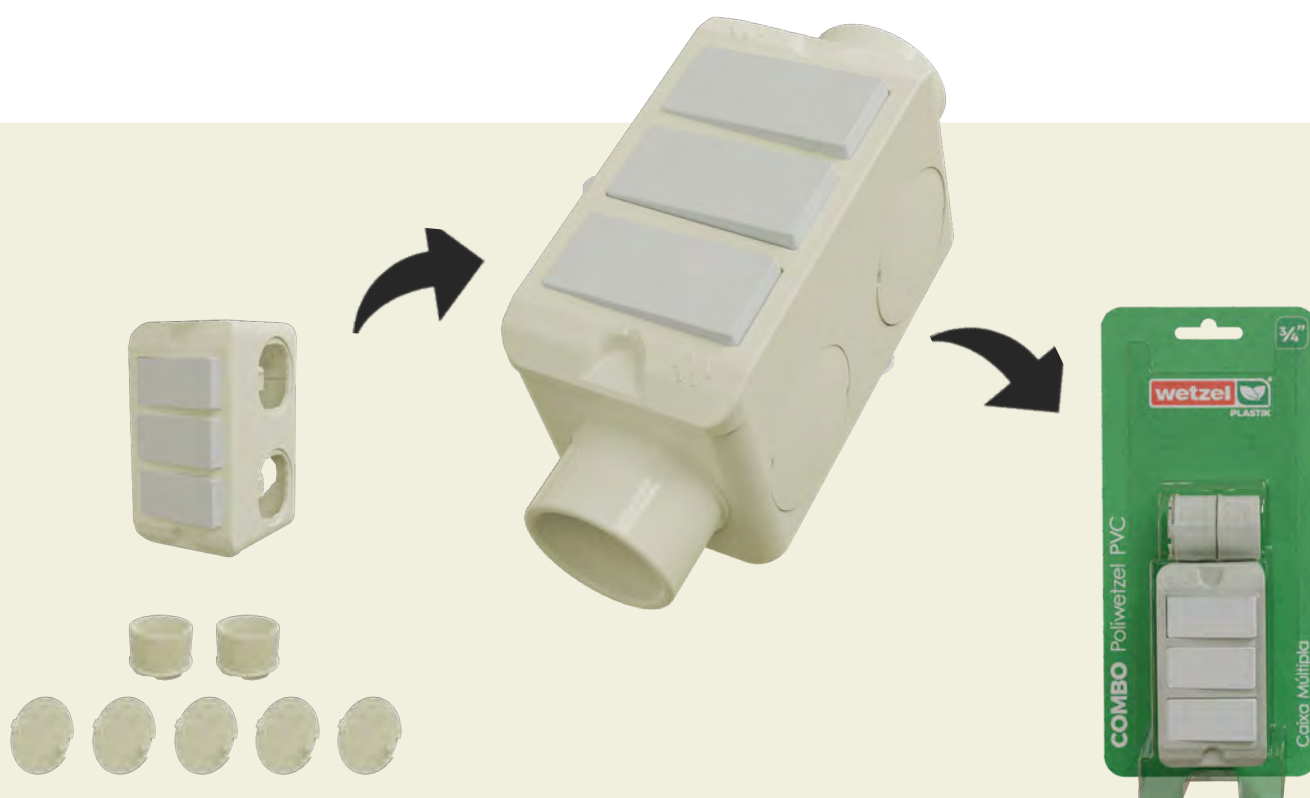

CONHEÇA OS COMBOS

- DISPONÍVEIS NAS BITOLAS 3/4" E 1"
- SOLUÇÕES COMPLETAS COM MECANISMOS MODULARES
- PRÁTICOS PARA ARMAZENAR E PREPARAR INSTALAÇÕES



COMBO POLIWETZEL®

CAIXA DE DERIVAÇÃO MÓVEL TIPO L COM 2 CONECTORES e 5 TAMPÕES



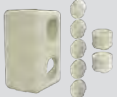

TAMPA CEGA

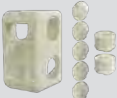
	CÓDIGO	REFERÊNCIA	DESCRIÇÃO	BITOLA	QT. EMB.
	E017212020	LPB6-15 CB PVC BR CEGO	TAMPA CEGA	3/4"	12

TAMPA MODULAR (SEM MECANISMO)

	CÓDIGO	REFERÊNCIA	DESCRIÇÃO	BITOLA	QT. EMB.
	E017212135	LPB6-15 CB PVC BR S/ MÓDULO	TRÊS POSTOS S/ MÓDULO	3/4"	12

TAMPA MODULAR (COM 1 MECANISMO)

	CÓDIGO	REFERÊNCIA	DESCRIÇÃO	BITOLA	QT. EMB.
	E017212027	LPB6-15 CB PVC BR 1 T 10A	UMA TOMADA 10A	3/4"	12
	E017212028	LPB6-15 CB PVC BR 1 INT SIM	UM INTERRUPTOR SIMPLES	3/4"	12
	E017212032	LPB6-15 CB PVC BR 1 T 20A	UMA TOMADA 20A	3/4"	12
	E017212037	LPB6-15 CB PVC BR 1 RJ45 CAT 5E	UMA TOMADA RJ45 CAT 5E	3/4"	12
	E017212038	LPB6-15 CB PVC BR 1 RJ11	UMA TOMADA RJ11	3/4"	12
	E017212128	LPB6-15 CB PVC BR 1 INT PARAL	UM INTERRUPTOR PARALELO	3/4"	12
	E017212137	LPB6-15 CB PVC BR 1 RJ45 CAT 6	UMA TOMADA RJ45 CAT 6	3/4"	12
	E017212138	LPB6-15 CB PVC BR 1 USB 5.0V 2.0A	UMA TOMADA USB 5.0V 2.0A	3/4"	12

COMBO POLIWETZEL® PVC BRANCO

COMBO POLIWETZEL®

CAIXA DE DERIVAÇÃO MÓVEL TIPO L COM 2 CONECTORES e 5 TAMPÕES

TAMPA MODULAR (COM 2 MECANISMOS)

	CÓDIGO	REFERÊNCIA	DESCRIÇÃO	BITOLA	QT. EMB.
	E017212023	LPB6-15 CB PVC BR 1 T 10A 1 INT SIM	UMA TOMADA 10A + UM INTERRUPTOR SIMPLES	3/4"	12
	E017212026	LPB6-15 CB PVC BR 1 RJ45 CAT 5E 1 RJ11	UMA TOMADA RJ45 CAT 5E + UMA TOMADA RJ11	3/4"	12
	E017212029	LPB6-15 CB PVC BR 2 T 10A	DUAS TOMADAS 10A	3/4"	12
	E017212030	LPB6-15 CB PVC BR 2 INT SIM	DOIS INTERRUPTORES SIMPLES	3/4"	12
	E017212031	LPB6-15 CB PVC BR 1 T 20A 1 INT SIM	UMA TOMADA 20A + UM INTERRUPTOR SIMPLES	3/4"	12
	E017212035	LPB6-15 CB PVC BR 2 T 20A	DUAS TOMADAS 20A	3/4"	12
	E017212036	LPB6-15 CB PVC BR 2 RJ45 CAT 5E	DUAS TOMADAS RJ45 CAT 5E	3/4"	12
	E017212123	LPB6-15 CB PVC BR 1 T 10A 1 INT PARAL	UMA TOMADA 10A + UM INTERRUPTOR PARALELO	3/4"	12
	E017212126	LPB6-15 CB PVC BR 1 RJ45 CAT 6 1 RJ11	UMA TOMADA RJ45 CAT 6 + UMA TOMADA RJ11	3/4"	12
	E017212130	LPB6-15 CB PVC BR 2 INT PARAL	DOIS INTERRUPTORES PARALELOS	3/4"	12
	E017212131	LPB6-15 CB PVC BR 1 T 20A 1 INT PARAL	UMA TOMADA 20A + UM INTERRUPTOR PARALELO	3/4"	12
	E017212136	LPB6-15 CB PVC BR 2 RJ45 CAT 6	DUAS TOMADAS RJ45 CAT 6	3/4"	12

COMBO POLIWETZEL®

CAIXA DE DERIVAÇÃO MÓVEL TIPO L COM 2 CONECTORES e 5 TAMPÕES

TAMPA MODULAR (COM 3 MECANISMOS)

	CÓDIGO	REFERÊNCIA	DESCRIÇÃO	BITOLA	QT. EMB.
	E017212021	LPB6-15 CB PVC BR 3 T 10A	TRÊS TOMADAS 10A	3/4"	12
	E017212022	LPB6-15 CB PVC BR 3 INT SIM	TRÊS INTERRUPTORES SIMPLES	3/4"	12
	E017212024	LPB6-15 CB PVC BR 2 T 10A 1 INT SIM	DUAS TOMADAS 10A + UM INTERRUPTOR SIMPLES	3/4"	12
	E017212025	LPB6-15 CB PVC BR 2 INT SIM 1 T 10A	DOIS INTERRUPTORES SIMPLES + UMA TOMADA 10A	3/4"	12
	E017212033	LPB6-15 CB PVC BR 2 T 20A 1 INT SIM	DUAS TOMADAS 20A + UM INTERRUPTOR SIMPLES	3/4"	12
	E017212034	LPB6-15 CB PVC BR 2 INT SIM 1 T 20A	DOIS INTERRUPTORES SIMPLES + UMA TOMADA 20A	3/4"	12
	E017212039	LPB6-15 CB PVC BR 3 T 20A	TRÊS TOMADAS 20A	3/4"	12
	E017212122	LPB6-15 CB PVC BR 3 INT PARAL	TRÊS INTERRUPTORES PARALELOS	3/4"	12
	E017212124	LPB6-15 CB PVC BR 2 T 10A 1 INT PARAL	DUAS TOMADAS 10A + UM INTERRUPTOR PARALELO	3/4"	12
	E017212125	LPB6-15 CB PVC BR 2 INT PARAL 1 T 10A	DOIS INTERRUPTORES PARALELOS + UMA TOMADA 10A	3/4"	12
	E017212133	LPB6-15 CB PVC BR 2 T 20A 1 INT PARAL	DUAS TOMADAS 20A + UM INTERRUPTOR PARALELO	3/4"	12
	E017212134	LPB6-15 CB PVC BR 2 INT PARAL 1 T 20A	DOIS INTERRUPTORES PARALELOS + UMA TOMADA 20A	3/4"	12

COMBO POLIWETZEL® PVC BRANCO

COMBO POLIWETZEL®

CAIXA DE DERIVAÇÃO MÓVEL TIPO L COM 2 CONECTORES e 5 TAMPÕES



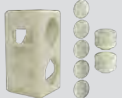

TAMPA CEGA

	CÓDIGO	REFERÊNCIA	DESCRIÇÃO	BITOLA	QT. EMB.
	E017212040	LPB6-20 CB PVC BR CEGO	TAMPA CEGA	1"	12

TAMPA MODULAR (SEM MECANISMO)

	CÓDIGO	REFERÊNCIA	DESCRIÇÃO	BITOLA	QT. EMB.
	E017212155	LPB6-20 CB PVC BR S/ MÓDULO	TRÊS POSTOS S/ MÓDULO	1"	12

TAMPA MODULAR (COM 1 MECANISMO)

	CÓDIGO	REFERÊNCIA	DESCRIÇÃO	BITOLA	QT. EMB.
	E017212047	LPB6-20 CB PVC BR 1 T 10A	UMA TOMADA 10A	1"	12
	E017212048	LPB6-20 CB PVC BR 1 INT SIM	UM INTERRUPTOR SIMPLES	1"	12
	E017212052	LPB6-20 CB PVC BR 1 T 20A	UMA TOMADA 20A	1"	12
	E017212057	LPB6-20 CB PVC BR 1 RJ45 CAT 5E	UMA TOMADA RJ45 CAT 5E	1"	12
	E017212058	LPB6-20 CB PVC BR 1 RJ11	UMA TOMADA RJ11	1"	12
	E017212148	LPB6-20 CB PVC BR 1 INT PARAL	UM INTERRUPTOR PARALELO	1"	12
	E017212159	LPB6-20 CB PVC BR 1 RJ45 CAT 6	UMA TOMADA RJ45 CAT 6	1"	12
	E017212160	LPB6-20 CB PVC BR 1 USB 5.0V 2.0A	UMA TOMADA USB 5.0V 2.0A	1"	12

COMBO POLIWETZEL®

CAIXA DE DERIVAÇÃO MÓVEL TIPO L COM 2 CONECTORES e 5 TAMPÕES

TAMPA MODULAR (COM 2 MECANISMOS)







	CÓDIGO	REFERÊNCIA	DESCRIÇÃO	BITOLA	QT. EMB.
	E017212043	LPB6-20 CB PVC BR 1 T 10A 1 INT SIM	UMA TOMADA 10A + UM INTERRUPTOR SIMPLES	1"	12
	E017212046	LPB6-20 CB PVC BR 1 RJ45 CAT 5E 1 RJ11	UMA TOMADA RJ45 CAT 5E + UMA TOMADA RJ11	1"	12
	E017212049	LPB6-20 CB PVC BR 2 T 10A	DUAS TOMADAS 10A	1"	12
	E017212050	LPB6-20 CB PVC BR 2 INT SIM	DOIS INTERRUPTORES SIMPLES	1"	12
	E017212051	LPB6-20 CB PVC BR 1 T 20A 1 INT SIM	UMA TOMADA 20A + UM INTERRUPTOR SIMPLES	1"	12
	E017212055	LPB6-20 CB PVC BR 2 T 20A	DUAS TOMADAS 20A	1"	12
	E017212056	LPB6-20 CB PVC BR 2 RJ45 CAT 5E	DUAS TOMADAS RJ45 CAT 5E	1"	12
	E017212143	LPB6-20 CB PVC BR 1 T 10A 1 INT PARAL	UMA TOMADA 10A + UM INTERRUPTOR PARALELO	1"	12
	E017212146	LPB6-20 CB PVC BR 1 RJ45 CAT 6, 1 RJ11	UMA TOMADA RJ45 CAT 6 + UMA TOMADA RJ11	1"	12
	E017212150	LPB6-20 CB PVC BR 2 INT PARAL	DOIS INTERRUPTORES PARALELOS	1"	12
	E017212151	LPB6-20 CB PVC BR 1 T 20A 1 INT PARAL	UMA TOMADA 20A + UM INTERRUPTOR PARALELO	1"	12
	E017212158	LPB6-20 CB PVC BR 2 RJ45 CAT 6	DUAS TOMADAS RJ45 CAT 6	1"	12

COMBO POLIWETZEL® PVC BRANCO

COMBO POLIWETZEL®

CAIXA DE DERIVAÇÃO MÓVEL TIPO L COM 2 CONECTORES e 5 TAMPÕES

TAMPA MODULAR (COM 3 MECANISMOS)

	CÓDIGO	REFERÊNCIA	DESCRIÇÃO	BITOLA	QT. EMB.
	E017212041	LPB6-20 CB PVC BR 3 T 10A	TRÊS TOMADAS 10A	1"	12
	E017212042	LPB6-20 CB PVC BR 3 INT SIM	TRÊS INTERRUPTORES SIMPLES	1"	12
	E017212044	LPB6-20 CB PVC BR 2 T 10A 1 INT SIM	DUAS TOMADAS 10A + UM INTERRUPTOR SIMPLES	1"	12
	E017212045	LPB6-20 CB PVC BR 2 INT SIM 1T 10A	DOIS INTERRUPTORES SIMPLES + UMA TOMADA 10A	1"	12
	E017212053	LPB6-20CB PVC BR 2 T 20A 1 INT SIM	DUAS TOMADAS 20A + UM INTERRUPTOR SIMPLES	1"	12
	E017212054	LPB6-20 CB PVC BR 2 INT SIM 1 T 20A	DOIS INTERRUPTORES SIMPLES + UMA TOMADA 20A	1"	12
	E017212059	LPB6-20 CB PVC BR 3 T 20A	TRÊS TOMADAS 20A	1"	12
	E017212142	LPB6-20 CB PVC BR 3 INT PARAL	TRÊS INTERRUPTORES PARALELOS	1"	12
	E017212144	LPB6-20 CB PVC BR 2 T 10A 1 INT PARAL	DUAS TOMADAS 10A + UM INTERRUPTOR PARALELO	1"	12
	E017212145	LPB6-20CB PVC BR 2 INT PARAL 1 T 10A	DOIS INTERRUPTORES PARALELOS + UMA TOMADA 10A	1"	12
	E017212153	LPB6-20CB PVC BR 2 T 20A 1 INT PARAL	DUAS TOMADAS 20A + UM INTERRUPTOR PARALELO	1"	12
	E017212154	LPB6-20 CB PVC BR 2 INT PARAL 1 T 20A	DOIS INTERRUPTORES PARALELOS + UMA TOMADA 20A	1"	12

POLIWETZEL®

CAIXA DE DERIVAÇÃO MÓVEL

DISPENSA O USO DE PARAFUSOS
TAMPA COM ENCAIXE
RÁPIDO POR PRESSÃO

MULTI ENCAIXE
DIVERSAS COMBINAÇÕES
PARA CONEXÕES EM
ELETRODUTOS

ENCAIXE FUNCIONAL
FACILITA A DESMONTAGEM
E MANUTENÇÃO
DAS INSTALAÇÕES

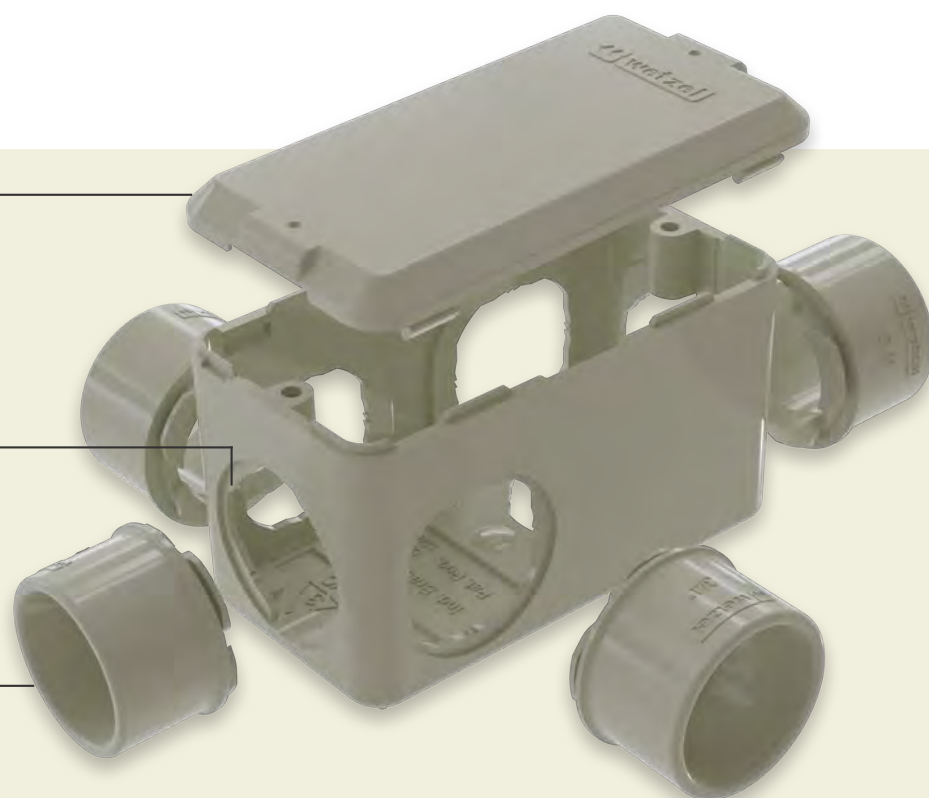

CONHEÇA MAIS SOBRE

- DISPONÍVEL NAS BITOLAS 1/2", 3/4" E 1"

ALTURA DIFERENCIADA
GARANTE MAIS VOLUME INTERNO







PRATICIDADE NA INSTALAÇÃO
E NA PASSAGEM DOS CABOS,
QUE EVITA O ESMAGAMENTO
E REDUZ RISCOS DE CURTOS
CIRCUITOS ELÉTRICOS.



PONTO DE APOIO
MANTÉM DISTÂNCIA DA
SUPERFÍCIE E EVITA O CONTATO
COM A UMIDADE.



CAIXA DE DERIVAÇÃO MÓVEL PEQUENA E ACESSÓRIOS - 1/2" e 3/4"

	CÓDIGO	REFERÊNCIA	DESCRIÇÃO	BITOLA	QT. EMB.
	E017210020	LPB6-10/15 CORPO PVC BR	CORPO E 4 TAMPÕES	1/2" e 3/4"	10
	E019610010	TPIB-10/15 PVC BR	TAMPÃO PARA POLIWETZEL PVC BRANCO 1/2" E 3/4"	1/2" e 3/4"	50
	E020710010	CPBL-10 PVC BR	CONECTOR P/ POLIWETZEL PVC BRANCO 1/2"	1/2"	20
	E020710015	CPBL-15 PVC BR	CONECTOR P/ POLIWETZEL PVC BRANCO 3/4"	3/4"	20
	E020810010	UNB-10/15 PVC BR	UNIÃO P/ POLIWETZEL PVC BRANCO 1/2" E 3/4"	1/2" e 3/4"	20
	E018010012	TPBC-10/15 PVC BR	TAMPA CEGA PVC BRANCO 1/2" E 3/4"	1/2" e 3/4"	10
	E018012844	TPBM-55 PVC BR	TAMPA MODULAR TRÊS POSTOS PVC BRANCO 1/2" E 3/4"	1/2" e 3/4"	10

CONECTORES COMPATÍVEIS

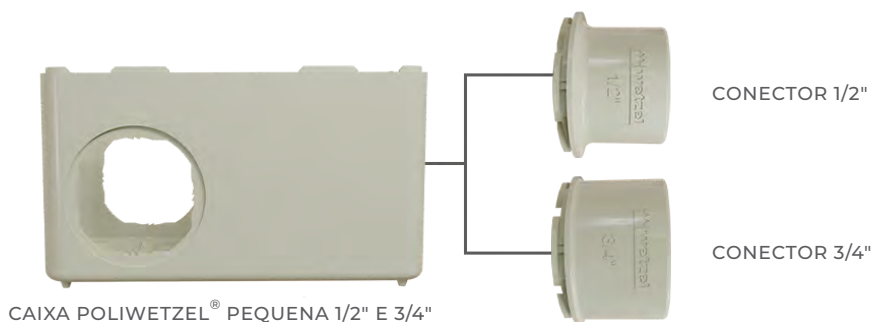

CAIXA DE DERIVAÇÃO MÓVEL GRANDE E ACESSÓRIOS - 1/2", 3/4" E 1"

	CÓDIGO	REFERÊNCIA	DESCRIÇÃO	BITOLA	QT. EMB.
	E017210040	LPB6-20 CORPO PVC BR	CORPO E 4 TAMPÕES	1"	10
	E019610020	TPIB-20 PVC BR	TAMPÃO PARA POLIWETZEL PVC BRANCO 1"	1"	50
	E020710020	CPBL-20 PVC BR	CONECTOR P/ POLIWETZEL PVC BRANCO 1"	1"	20
	E020410010	CPBL-10 SU PVC BR	CONECTOR SAÍDAS UNIFICADAS PVC BRANCO 1/2" P/ POLIWETZEL 1"	1/2"	20
	E020410015	CPBL-15 SU PVC BR	CONECTOR SAÍDAS UNIFICADAS PVC BRANCO 3/4" P/ POLIWETZEL 1"	3/4"	20
	E020810020	UNB-20 PVC BR	UNIÃO P/ POLIWETZEL PVC BRANCO 1"	1"	20
	E018010032	TPBC-20 PVC BR	TAMPA CEGA PVC BRANCO 1"	1"	10
	E018012854	TPBM-66 PVC BR	TAMPA MODULAR TRÊS POSTOS PVC BRANCO 1"	1"	10

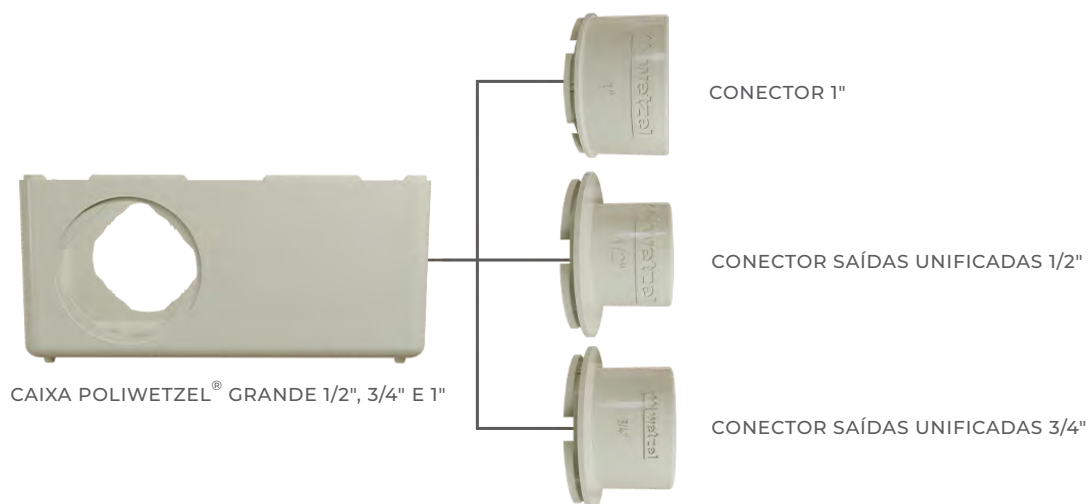

CONECTORES COMPATÍVEIS









A caixa múltipla grande (Poliwetzl®) de 1" é compatível com 3 bitolas, conforme o passo a passo na página 11.

TAMPAS PARA POLIWETZEL® PVC BRANCO

*TAMPA MODULAR

	CÓDIGO	REFERÊNCIA	DESCRIÇÃO	BITOLA	QT. EMB.
	E018012844	TPBM-55 PVC BR	TRÊS POSTOS	1/2" e 3/4"	10
	E018012854	TPBM-66 PVC BR	TRÊS POSTOS	1"	10

TAMPA MODULAR | TOMADAS RJ

	CÓDIGO	REFERÊNCIA	DESCRIÇÃO	BITOLA	QT. EMB.
	E018012846	TPBM-55 PVC BR + MÓDULO P/ RJ45	PARA UMA TOMADA RJ45	1/2" e 3/4"	10
	E018012847	TPBM-55 PVC BR + 2 MÓDULOS P/ RJ45	PARA DUAS TOMADAS RJ45	1/2" e 3/4"	10
	E018012848	TPBM-55 PVC BR + RJ45 CAT 5E	COM UMA TOMADA RJ45 CAT 5E	1/2" e 3/4"	10
	E018012849	TPBM-55 PVC BR + 2 RJ45 CAT 5E	COM DUAS TOMADAS RJ45 CAT 5E	1/2" e 3/4"	10
	E018012856	TPBM-66 PVC BR + MÓDULO P/ RJ45	PARA UMA TOMADA RJ45	1"	10
	E018012857	TPBM-66 PVC BR + 2 MÓDULOS P/ RJ45	PARA DUAS TOMADAS RJ45	1"	10
	E018012858	TPBM-66 PVC BR + RJ45 CAT 5E	COM UMA TOMADA RJ45 CAT 5E	1"	10
	E018012859	TPBM-66 PVC BR + 2 RJ45 CAT 5E	COM DUAS TOMADAS RJ45 CAT 5E	1"	10

*As tampas modulares foram projetadas para acompanhar os módulos Wetzel da Linha Industrie.

LINHA INDUSTRIE MECANISMOS MODULARES

MÓDULOS WETZEL



ESPECIALMENTE DESENVOLVIDOS PARA AS TAMPAS MODULARES DE POLIWETZEL E CONDULETZEL.

Disponíveis nas páginas 137 e 138



TAMPAS PARA POLIWETZEL® PVC BRANCO

TAMPA CEGA

	CÓDIGO	REFERÊNCIA	DESCRIÇÃO	BITOLA	QT. EMB.
	E018010012	TPBC-10/15 PVC BR	CEGA	1/2" e 3/4"	10
	E018010032	TPBC-20 PVC BR	CEGA	1"	10

TAMPA MONOBLOCO

	CÓDIGO	REFERÊNCIA	DESCRIÇÃO	BITOLA	QT. EMB.
	E018010122	TPBA-01 PVC BR	PARA UM INTERRUPTOR VERTICAL	1/2" e 3/4"	10
	E018010132	*TPBA-02 PVC BR	PARA DOIS INTERRUPTORES HORIZONTAIS JUNTOS	1/2" e 3/4"	10
	E018010142	TPBA-03 PVC BR	PARA TRÊS INTERRUPTORES HORIZONTAIS JUNTOS	1/2" e 3/4"	10
	E018010152	TPBA-04 PVC BR	PARA DOIS INTERRUPTORES HORIZONTAIS SEPARADOS	1/2" e 3/4"	10
	E018010162	TPBA-05 PVC BR	PARA UMA TOMADA REDONDA	1/2" e 3/4"	10
	E018012814	TPBA-35 PVC BR	PARA UMA TOMADA HEXAGONAL VERTICAL	1/2" e 3/4"	10
	E018010282	TPBA-12 PVC BR	PARA UM INTERRUPTOR VERTICAL	1"	10
	E018010292	*TPBA-13 PVC BR	PARA DOIS INTERRUPTORES HORIZONTAIS JUNTOS	1"	10

TAMPAS PARA POLIWETZEL® PVC BRANCO

TAMPA MONOBLOCO

	CÓDIGO	REFERÊNCIA	DESCRIÇÃO	BITOLA	QT. EMB.
	E018010302	TPBA-14 PVC BR	PARA TRÊS INTERRUPTORES HORIZONTAIS JUNTOS	1"	10
	E018010312	TPBA-15 PVC BR	PARA DOIS INTERRUPTORES HORIZONTAIS SEPARADOS	1"	10
	E018010013	TPBA-16 PVC BR	PARA UMA TOMADA REDONDA	1"	10
	E018010014	TPBA-17 PVC BR	PARA UMA TOMADA REDONDA	1"	10
	E018010402	TPBA-24 PVC BR	PARA DUAS TOMADAS REDONDAS	1"	10
	E018012815	TPBA-36 PVC BR	PARA DUAS TOMADAS HEXAGONAIS HORIZONTAIS SEPARADAS	1"	10
	E018012816	TPBA-37 PVC BR	PARA UM INTERRUPTOR E UMA TOMADA HEXAGONAL SEPARADOS	1"	10
	E018012817	TPBA-38 PVC BR	PARA DOIS INTERRUPTORES JUNTOS E UMA TOMADA HEXAGONAL HORIZONTAL SEPARADA	1"	10

MECANISMO MONOBLOCO (SOB CONSULTA)

	CÓDIGO	REFERÊNCIA	DESCRIÇÃO	COR	QT. EMB.
	E020900041	INT BI 10A/250V~	INTERRUPTOR BIPOLAR (SIMPLES/PARALELO) 10A-250V~	BRANCO	25

*COMPATÍVEL COM A TAMPA TPBA-02 E TPBA-13, PÁGINA 83.

CONHEÇA NOSSA LINHA **LED**



ACESSE E BAIXE



www.WETZEL.com.br



CONDULETZEL[®]

CAIXA DE DERIVAÇÃO FIXA

ACOMPANHA PARAFUSOS
COM TRATAMENTO ESPECIAL

SEM ROSCA
CONEXÃO POR
MEIO DE ENCAIXE

CONHEÇA MAIS SOBRE

- DISPONÍVEL NAS BITOLAS 1/2", 3/4" E 1"
- DIVERSAS COMBINAÇÕES PARA CONEXÕES EM ELETRODUTOS

MODELOS DISPONÍVEIS:



C

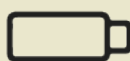

E

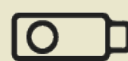

LB

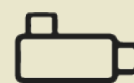

LL

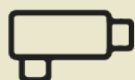

LR



T

















TB



X





CAIXA DE DERIVAÇÃO FIXA



	CÓDIGO	REFERÊNCIA	DESCRIÇÃO	TIPO	BITOLA	QT. EMB.
	E013021021	CBSR-10 CORPO PVC BR	CAIXA FIXA CONDULETZEL BR TIPO C 1/2" S/ TP S/ VED S/ R	C	1/2"	5
	E013031021	EBSR-10 CORPO PVC BR	CAIXA FIXA CONDULETZEL BR TIPO E 1/2" S/ TP S/ VED S/ R	E	1/2"	5
	E013041021	LBBSR-10 CORPO PVC BR	CAIXA FIXA CONDULETZEL BR TIPO LB 1/2" S/ TP S/ VED S/ R	LB	1/2"	5
	E013051021	LLBSR-10 CORPO PVC BR	CAIXA FIXA CONDULETZEL BR TIPO LL 1/2" S/ TP S/ VED S/ R	LL	1/2"	5
	E013061021	LRBSR-10 CORPO PVC BR	CAIXA FIXA CONDULETZEL BR TIPO LR 1/2" S/ TP S/ VED S/ R	LR	1/2"	5
	E013071021	TBSR-10 CORPO PVC BR	CAIXA FIXA CONDULETZEL BR TIPO T 1/2" S/ TP S/ VED S/ R	T	1/2"	5
	E013091021	TBBSR-10 CORPO PVC BR	CAIXA FIXA CONDULETZEL BR TIPO TB 1/2" S/ TP S/ VED S/ R	TB	1/2"	5
	E013101021	XBSR-10 CORPO PVC BR	CAIXA FIXA CONDULETZEL BR TIPO X 1/2" S/ TP S/ VED S/ R	X	1/2"	5
	E013021031	CBSR-15 CORPO PVC BR	CAIXA FIXA CONDULETZEL BR TIPO C 3/4" S/ TP S/ VED S/ R	C	3/4"	5
	E013031031	EBSR-15 CORPO PVC BR	CAIXA FIXA CONDULETZEL BR TIPO E 3/4" S/ TP S/ VED S/ R	E	3/4"	5
	E013041031	LBBSR-15 CORPO PVC BR	CAIXA FIXA CONDULETZEL BR TIPO LB 3/4" S/ TP S/ VED S/ R	LB	3/4"	5
	E013051031	LLBSR-15 CORPO PVC BR	CAIXA FIXA CONDULETZEL BR TIPO LL 3/4" S/ TP S/ VED S/ R	LL	3/4"	5
	E013061031	LRBSR-15 CORPO PVC BR	CAIXA FIXA CONDULETZEL BR TIPO LR 3/4" S/ TP S/ VED S/ R	LR	3/4"	5
	E013071031	TBSR-15 CORPO PVC BR	CAIXA FIXA CONDULETZEL BR TIPO T 3/4" S/ TP S/ VED S/ R	T	3/4"	5
	E013091031	TBBSR-15 CORPO PVC BR	CAIXA FIXA CONDULETZEL BR TIPO TB 3/4" S/ TP S/ VED S/ R	TB	3/4"	5

CONDULETZEL® PVC BRANCO



CAIXA DE DERIVAÇÃO FIXA

	CÓDIGO	REFERÊNCIA		TIPO	BITOLA	QT. EMB.
	E013101031	XBSR-15 CORPO PVC BR	CAIXA FIXA CONDULETZEL BR TIPO X 3/4" S/ TP S/ VED S/ R	X	3/4"	5
	E013021041	CBSR-20 CORPO PVC BR	CAIXA FIXA CONDULETZEL BR TIPO C 1" S/ TP S/ VED S/ R	C	1"	5
	E013031041	EBSR-20 CORPO PVC BR	CAIXA FIXA CONDULETZEL BR TIPO E 1" S/ TP S/ VED S/ R	E	1"	5
	E013041041	LBBSR-20 CORPO PVC BR	CAIXA FIXA CONDULETZEL BR TIPO LB 1" S/ TP S/ VED S/ R	LB	1"	5
	E013051041	LLBSR-20 CORPO PVC BR	CAIXA FIXA CONDULETZEL BR TIPO LL 1" S/ TP S/ VED S/ R	LL	1"	5
	E013061041	LRBSR-20 CORPO PVC BR	CAIXA FIXA CONDULETZEL BR TIPO LR 1" S/ TP S/ VED S/ R	LR	1"	5
	E013071041	TBSR-20 CORPO PVC BR	CAIXA FIXA CONDULETZEL BR TIPO T 1" S/ TP S/ VED S/ R	T	1"	5
	E013091041	TBBSR-20 CORPO PVC BR	CAIXA FIXA CONDULETZEL BR TIPO TB 1" S/ TP S/ VED S/ R	TB	1"	5
	E013101041	XBSR-20 CORPO PVC BR	CAIXA FIXA CONDULETZEL BR TIPO X 1" S/ TP S/ VED S/ R	X	1"	5

*TAMPA MODULAR

	CÓDIGO	REFERÊNCIA	DESCRIÇÃO	BITOLA	QT. EMB.
	E014012844	TCBM-55 PVC BR	TRÊS POSTOS	1/2" e 3/4"	10
	E014012854	TCBM-66 PVC BR	TRÊS POSTOS	1"	10

TAMPA MODULAR | TOMADAS RJ

	CÓDIGO	REFERÊNCIA	DESCRIÇÃO	BITOLA	QT. EMB.
	E014012846	TCBM-55 PVC BR + MÓDULO P/ RJ45	PARA UMA TOMADA RJ 45	1/2" e 3/4"	10
	E014012847	TCBM-55 PVC BR + 2 MÓDULOS P/ RJ45	PARA DUAS TOMADAS RJ 45	1/2" e 3/4"	10

TAMPA MODULAR | TOMADAS RJ

	CÓDIGO	REFERÊNCIA	DESCRIÇÃO	BITOLA	QT. EMB.
	E014012848	TCBM-55 PVC BR + RJ45 CAT 5E	COM UMA TOMADA RJ45 CAT 5E	1/2" e 3/4"	10
	E014012849	TCBM-55 PVC BR + 2 RJ45 CAT 5E	COM DUAS TOMADAS RJ45 CAT 5E	1/2" e 3/4"	10
	E014012856	TCBM-66 PVC BR + MÓDULO P/ RJ45	PARA UMA TOMADA RJ45	1"	10
	E014012857	TCBM-66 PVC BR + 2 MÓDULOS P/ RJ45	PARA DUAS TOMADAS RJ45	1"	10
	E014012858	TCBM-66 PVC BR + RJ45 CAT 5E	COM UMA TOMADA RJ45 CAT 5E	1"	10
	E014012859	TCBM-66 PVC BR + 2 RJ45 CAT 5E	COM DUAS TOMADAS RJ45 CAT 5E	1"	10

*As tampas modulares foram projetadas para acompanhar os módulos Wetzel da Linha Industrie.

LINHA INDUSTRIE

MECANISMOS MODULARES

MÓDULOS WETZEL

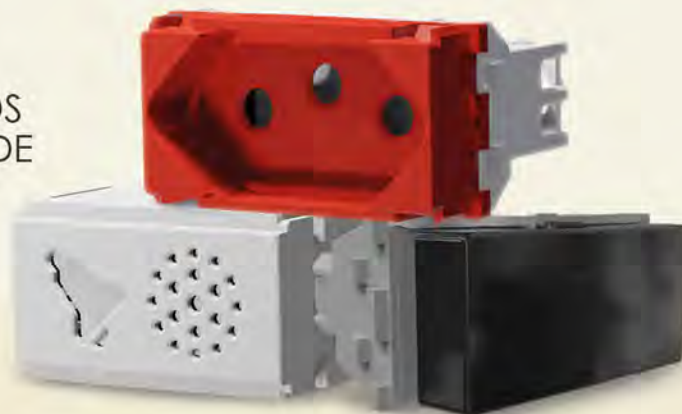

ESPECIALMENTE DESENVOLVIDOS
PARA AS TAMPAS MODULARES DE
POLIWETZEL E CONDULETZEL.





Disponíveis nas páginas 137 e 138

TAMPAS PARA CONDULETZEL® PVC BRANCO

TAMPA CEGA



	CÓDIGO	REFERÊNCIA	DESCRIÇÃO	BITOLA	QT. EMB.
	E014010012	TCBC-10/15 PVC BR	CEGA	1/2" e 3/4"	10
	E014010032	TCBC-20 PVC BR	CEGA	1"	10

TAMPA MONOBLOCO

	CÓDIGO	REFERÊNCIA	DESCRIÇÃO	BITOLA	QT. EMB.
	E014010122	TCBA-01 PVC BR	PARA UM INTERRUPTOR VERTICAL	1/2" e 3/4"	10
	E014010132	*TCBA-02 PVC BR	PARA DOIS INTERRUPTORES HORIZONTAIS JUNTOS	1/2" e 3/4"	10
	E014010142	TCBA-03 PVC BR	PARA TRÊS INTERRUPTORES HORIZONTAIS JUNTOS	1/2" e 3/4"	10
	E014010152	TCBA-04 PVC BR	PARA DOIS INTERRUPTORES HORIZONTAIS SEPARADOS	1/2" e 3/4"	10
	E014010162	TCBA-05 PVC BR	PARA UMA TOMADA REDONDA	1/2" e 3/4"	10
	E014012814	TCBA-35 PVC BR	PARA UMA TOMADA HEXAGONAL VERTICAL	1/2" e 3/4"	10
	E014010013	TCBA-16 PVC BR	PARA UMA TOMADA REDONDA	1"	10
	E014010014	TCBA-17 PVC BR	PARA UMA TOMADA REDONDA	1"	10
	E014010422	TCBA-24 PVC BR	PARA DUAS TOMADAS REDONDAS	1"	10

TAMPAS PARA CONDULETZEL® PVC BRANCO

TAMPA MONOBLOCO

	CÓDIGO	REFERÊNCIA	DESCRIÇÃO	BITOLA	QT. EMB.
	E014012820	TCBA-36 PVC BR	PARA DUAS TOMADAS HEXAGONAIS HORIZONTAIS SEPARADAS	1"	10
	E014012830	TCBA-37 PVC BR	PARA UM INTERRUPTOR E UMA TOMADA HEXAGONAL HORIZONTAL	1"	10
	E014012840	TCBA-38 PVC BR	PARA DOIS INTERRUPTORES HORIZONTAIS JUNTOS E UMA TOMADA HEXAGONAL HORIZONTAL SEPARADA	1"	10

MECANISMO MONOBLOCO (SOB CONSULTA)

	CÓDIGO	REFERÊNCIA	DESCRIÇÃO	COR	QT. EMB.
	E020900041	INT BI 10A/250V~	INTERRUPTOR BIPOLAR (SIMPLES/PARALELO) 10A-250V~	BRANCO	25

*COMPATÍVEL COM A TAMPA TCBA-02, PÁGINA 90.

ELETRODUTOS, TUBOS E ACESSÓRIOS

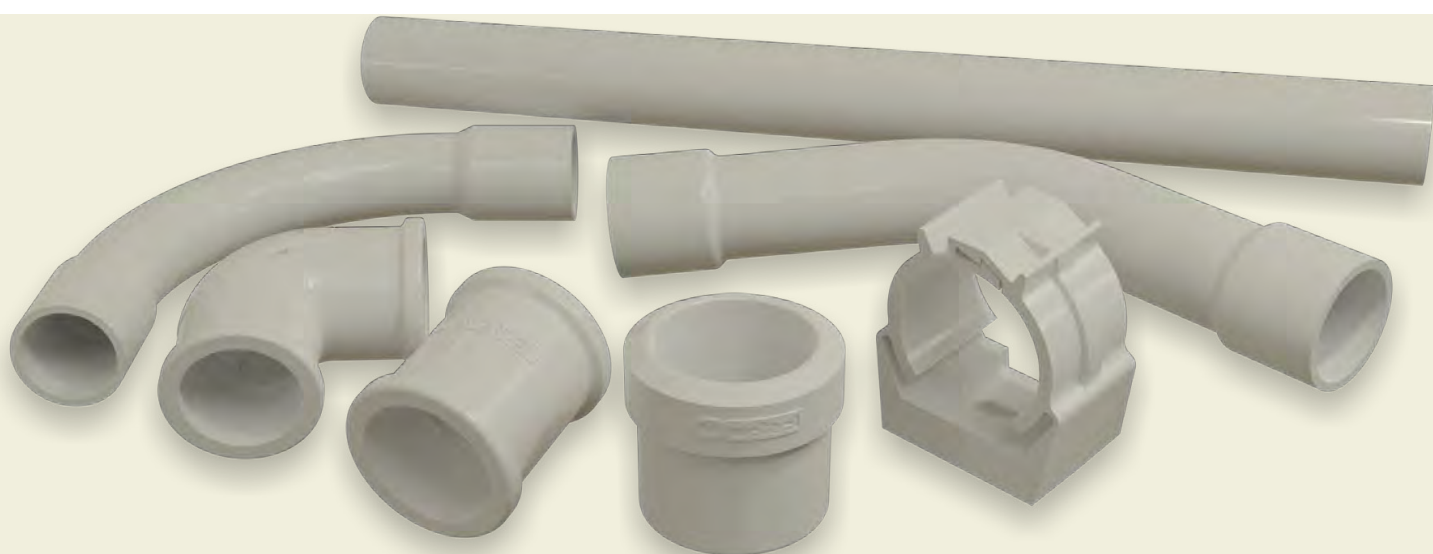

CONHEÇA MAIS SOBRE

ELETRODUTOS

- **ELETRODUTO PLASTIK CLASSE A**
PAREDE EXTRA PARA AMBIENTES **INDUSTRIAIS** E/OU SUJEITOS À GRANDES **SOLICITAÇÕES MECÂNICAS**
- **ELETRODUTO PLASTIK PESADO**
SEGURANÇA PARA INSTALAÇÕES **PROFISSIONAIS** EM AMBIENTES **INDUSTRIAIS**

TUBOS

- **ELETROWETZEL PLASTIK MAX**
VERSATILIDADE E CUSTO-BENEFÍCIO PARA AMBIENTES **COMERCIAIS**
- **ELETROWETZEL PLASTIK STANDARD**
QUALIDADE PARA AMBIENTES **RESIDENCIAIS** E/OU COM FINALIDADE **DECORATIVA**



ELETRODUTO E TUBOS PVC BRANCO

ELETRODUTOS

ELETRODUTO PLASTIK CLASSE A (SEM ROSCA)						SOB CONSULTA
	CÓDIGO	REFERÊNCIA	DESCRIÇÃO	ESPESSURA (mm)	BITOLA	QT. MÍN.
	E020310315	EAB-15 PVC BR	ELETRODUTO RÍGIDO CLASSE A PVC BRANCO 3/4"	2,6	3/4"	300

	E020310320	EAB-20 PVC BR	ELETRODUTO RÍGIDO CLASSE A PVC BRANCO 1"	3,2	1"	300
---	------------	---------------	--	-----	----	-----

ELETRODUTO PLASTIK PESADO (SEM ROSCA)						
	CÓDIGO	REFERÊNCIA	DESCRIÇÃO	ESPESSURA (mm)	BITOLA	QT. EMB.

	E020310010	EPB-10 PVC BR	ELETRODUTO RÍGIDO PESADO PVC BRANCO 1/2"	2	1/2"	20
---	------------	---------------	--	---	------	----

	E020310015	EPB-15 PVC BR	ELETRODUTO RÍGIDO PESADO PVC BRANCO 3/4"	2,5	3/4"	20
---	------------	---------------	--	-----	------	----

	E020310020	EPB-20 PVC BR	ELETRODUTO RÍGIDO PESADO PVC BRANCO 1"	2,8	1"	10
--	------------	---------------	--	-----	----	----

	E020310025	EPB-25 PVC BR	ELETRODUTO RÍGIDO PESADO PVC BRANCO 1.1/4"	2,9	1.1/4"	5
---	------------	---------------	--	-----	--------	---

	E020310030	EPB-30 PVC BR	ELETRODUTO RÍGIDO PESADO PVC BRANCO 1.1/2"	3,0	1.1/2"	5
---	------------	---------------	--	-----	--------	---

	E020310035	EPB-35 PVC BR	ELETRODUTO RÍGIDO PESADO PVC BRANCO 2"	3,1	2"	5
---	------------	---------------	--	-----	----	---

TUBOS

ELETROWETZEL PLASTIK MAX (SEM ROSCA)						
	CÓDIGO	REFERÊNCIA	DESCRIÇÃO	ESPESSURA (mm)	BITOLA	QT. EMB.

	E020310210	EMB-10 PVC BR	ELETROWETZEL RÍGIDO PLASTIK MAX PVC BRANCO 1/2"	1,5	1/2"	20
---	------------	---------------	---	-----	------	----

	E020310215	EMB-15 PVC BR	ELETROWETZEL RÍGIDO PLASTIK MAX PVC BRANCO 3/4"	1,5	3/4"	20
---	------------	---------------	---	-----	------	----





	E020310220	EMB-20 PVC BR	ELETROWETZEL RÍGIDO PLASTIK MAX PVC BRANCO 1"	1,7	1"	10
---	------------	---------------	---	-----	----	----

ACESSÓRIOS PVC BRANCO

ELETROWETZEL PLASTIK STANDARD (SEM ROSCA)

	CÓDIGO	REFERÊNCIA	DESCRIÇÃO	ESPESSURA (mm)	BITOLA	QT. EMB.
	E020310110	ESB-10 PVC BR	ELETROWETZEL RÍGIDO PLASTIK STANDARD PVC BRANCO 1/2"	1,2	1/2"	20
	E020310115	ESB-15 PVC BR	ELETROWETZEL RÍGIDO PLASTIK STANDARD PVC BRANCO 3/4"	1,2	3/4"	20
	E020310120	ESB-20 PVC BR	ELETROWETZEL RÍGIDO PLASTIK STANDARD PVC BRANCO 1"	1,4	1"	10



ABRAÇADEIRA

	CÓDIGO	REFERÊNCIA	DESCRIÇÃO	BITOLA	QT. EMB.
	E015510010	ABB-10 PP BR	ABRAÇADEIRA BRANCA 1/2"	1/2"	50
	E015510015	ABB-15 PP BR	ABRAÇADEIRA BRANCA 3/4"	3/4"	50
	E015510020	ABB-20 PP BR	ABRAÇADEIRA BRANCA 1"	1"	50
	E015510025	ABB-25 PP BR	ABRAÇADEIRA BRANCA 1.1/4"	1.1/4"	20
	E015510030	ABB-30 PP BR	ABRAÇADEIRA BRANCA 1.1/2"	1.1/2"	20
	E015510035	ABB-35 PP BR	ABRAÇADEIRA BRANCA 2"	2"	20

LUVA (SEM ROSCA)

	CÓDIGO	REFERÊNCIA	DESCRIÇÃO	BITOLA	QT. EMB.
	E015210010	LB-10 PVC BR	LUVA SEM ROSCA BRANCA 1/2"	1/2"	20
	E015210015	LB-15 PVC BR	LUVA SEM ROSCA BRANCA 3/4"	3/4"	20
	E015210020	LB-20 PVC BR	LUVA SEM ROSCA BRANCA 1"	1"	20



BUCHA DE REDUÇÃO (SEM ROSCA)

	CÓDIGO	REFERÊNCIA	DESCRIÇÃO	BITOLA	QT. EMB.
	E015410010	BRB-15/10 PVC BR	BUCHA DE REDUÇÃO SEM ROSCA BRANCA 3/4x1/2"	3/4" X 1/2"	20
	E015410015	BRB-20/15 PVC BR	BUCHA DE REDUÇÃO SEM ROSCA BRANCA 1x3/4"	1" X 3/4"	20



APLICAÇÃO DE BUCHA DE REDUÇÃO EM CAIXA FIXA



CURVA COM 45° PLASTIK MAX (COM DUAS BOLSAS)



	CÓDIGO	REFERÊNCIA	DESCRIÇÃO	BITOLA	QT. EMB.
	E020610010	C45B-10 PVC BR	CURVA 45° C/ 2 BOLSAS BRANCA 1/2"	1/2"	10
	E020610015	C45B-15 PVC BR	CURVA 45° C/ 2 BOLSAS BRANCA 3/4"	3/4"	10
	E020610020	C45B-20 PVC BR	CURVA 45° C/ 2 BOLSAS BRANCA 1"	1"	10

CURVA COM 90° PLASTIK MAX (COM DUAS BOLSAS)



	CÓDIGO	REFERÊNCIA	DESCRIÇÃO	BITOLA	QT. EMB.
	E020110010	C90B-10 PVC BR	CURVA 90° C/ 2 BOLSAS BRANCA 1/2"	1/2"	10
	E020110015	C90B-15 PVC BR	CURVA 90° C/ 2 BOLSAS BRANCA 3/4"	3/4"	10
	E020110020	C90B-20 PVC BR	CURVA 90° C/ 2 BOLSAS BRANCA 1"	1"	10

ACESSÓRIOS PVC BRANCO

CURVA COM 90° PLASTIK STANDARD (COM DUAS BOLSAS)

	CÓDIGO	REFERÊNCIA	DESCRIÇÃO	BITOLA	QT. EMB.
	E020111010	CS90B-10 PVC BR	CURVA STANDARD 90° C/ 2 BOLSAS BRANCA 1/2"	1/2"	10
	E020111015	CS90B-15 PVC BR	CURVA STANDARD 90° C/ 2 BOLSAS BRANCA 3/4"	3/4"	10
	E020111020	CS90B-20 PVC BR	CURVA STANDARD 90° C/ 2 BOLSAS BRANCA 1"	1"	10

COTOVELO COM 90° (COM TAMPA VIGIA SEM ROSCA)

	CÓDIGO	REFERÊNCIA	DESCRIÇÃO	BITOLA	QT. EMB.
	E015310010	CB-10 PVC BR	COTOVELO COM TAMPA VIGIA EM PVC SEM ROSCA BRANCO 1/2"	1/2"	20
	E015310015	CB-15 PVC BR	COTOVELO COM TAMPA VIGIA EM PVC SEM ROSCA BRANCO 3/4"	3/4"	20
	E015310020	CB-20 PVC BR	COTOVELO COM TAMPA VIGIA EM PVC SEM ROSCA BRANCO 1"	1"	20

CONHEÇA NOSSA LINHA **CONDULETZEL**



ACESSE E BAIXE



www.WETZEL.com.br



LINHA BRANCO PRO

Indicada para uso profissional em **ambientes hospitalares** e **alimentícios** devido aos rigorosos padrões de segurança e desempenho necessários. Sendo mais uma opção de cor para escolha.



Não propaga
chamas



Não conduz
eletricidade



Praticidade
no encaixe



Apta para
reciclagem



COMBOS POLIWETZEL®

PÁGINAS
100 a 106

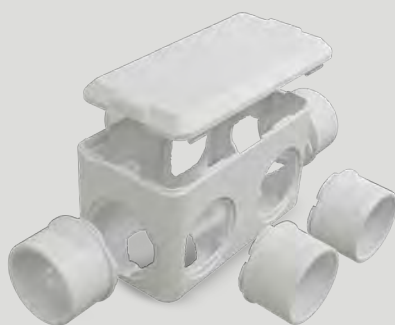

POLIWETZEL®

PÁGINAS
107 a 112



TUBOS E ACESSÓRIOS

PÁGINAS
114 a 117

COMBOS POLIWETZEL®

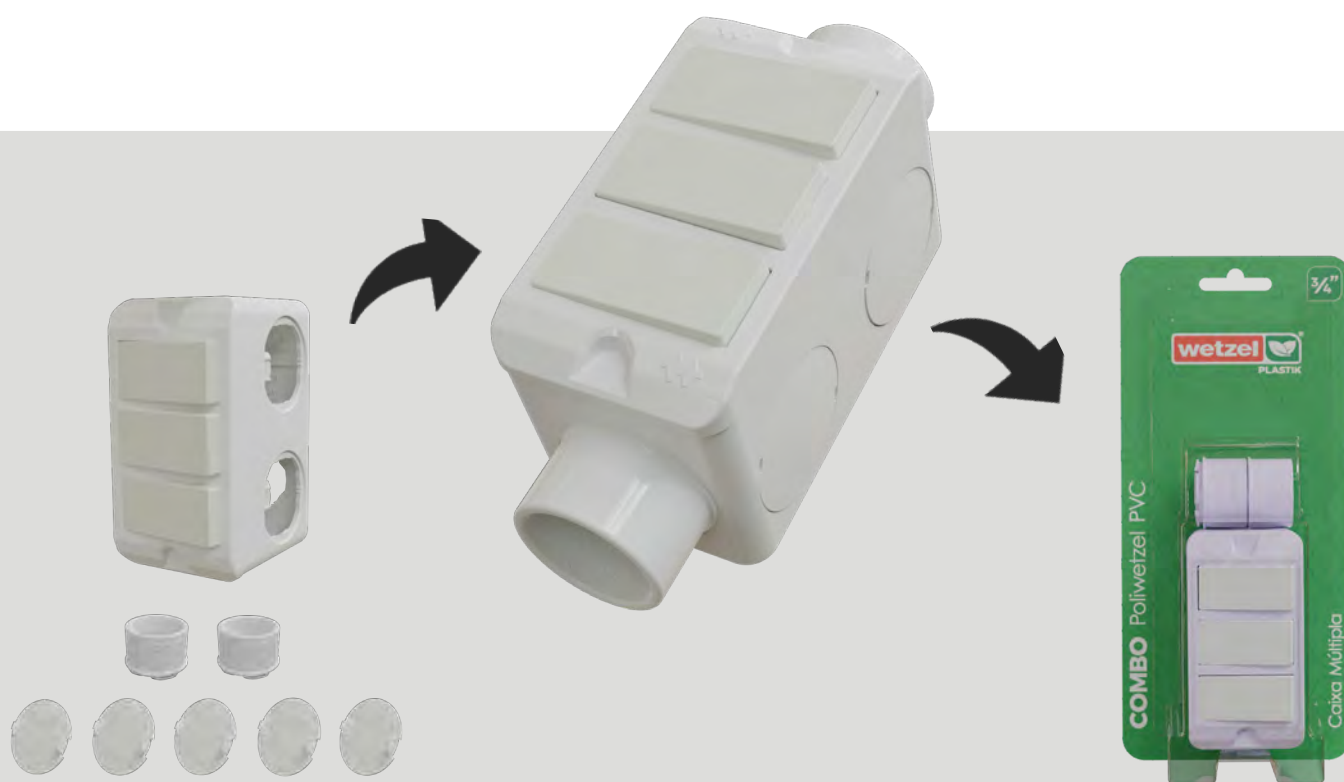

CONHEÇA OS COMBOS

- DISPONÍVEIS NAS BITOLAS 3/4" E 1"
- SOLUÇÕES COMPLETAS COM MECANISMOS MODULARES
- PRÁTICOS PARA **ARMAZENAR E PREPARAR** INSTALAÇÕES



COMBO POLIWETZEL®

CAIXA DE DERIVAÇÃO MÓVEL TIPO L COM 2 CONECTORES E 5 TAMPÕES

TAMPA CEGA

	CÓDIGO	REFERÊNCIA	DESCRIÇÃO	BITOLA	QT. EMB.
	E017212161	LPBPRO6-15 CB PVC BR PRO CEGO	TAMPA CEGA	3/4"	12

TAMPA MODULAR (SEM MECANISMO)

	CÓDIGO	REFERÊNCIA	DESCRIÇÃO	BITOLA	QT. EMB.
	E017212211	LPBPRO6-15 CB PVC BR PRO S/ MÓDULO	TRÊS POSTOS S/ MÓDULO	3/4"	12

TAMPA MODULAR (COM 1 MECANISMO)



	CÓDIGO	REFERÊNCIA	DESCRIÇÃO	BITOLA	QT. EMB.
	E017212168	LPBPRO6-15 CB PVC BR PRO 1 T 10A	UMA TOMADA 10A	3/4"	12
	E017212169	LPBPRO6-15 CB PVC BR PRO 1 INT SIM	UM INTERRUPTOR SIMPLES	3/4"	12
	E017212173	LPBPRO6-15 CB PVC BR PRO 1 T 20A	UMA TOMADA 20A	3/4"	12
	E017212178	LPBPRO6-15 CB PVC BR PRO 1 RJ45 CAT 5E	UMA TOMADA RJ45 CAT 5E	3/4"	12
	E017212179	LPBPRO6-15 CB PVC BR PRO 1 RJ11	UMA TOMADA RJ11	3/4"	12
	E017212206	LPBPRO6-15 CB PVC BR PRO 1 INT PARAL	UM INTERRUPTOR PARALELO	3/4"	12
	E017212213	LPBPRO6-15 CB PVC BR PRO 1 RJ45 CAT 6	UMA TOMADA RJ45 CAT 6	3/4"	12
	E017212214	LPBPRO6-15 CB PVC BR PRO 1 USB 5.0V 2.0A	UMA TOMADA USB 5.0V 2.0A	3/4"	12

COMBO POLIWETZEL® PVC BRANCO PRO

COMBO POLIWETZEL®

CAIXA DE DERIVAÇÃO MÓVEL TIPO L COM 2 CONECTORES E 5 TAMPÕES













TAMPA MODULAR (COM 2 MECANISMOS)

	CÓDIGO	REFERÊNCIA	DESCRIÇÃO	BITOLA	QT. EMB.
	E017212164	LPBPRO6-15 CB PVC BR PRO 1 T 10A 1 INT SIM	UMA TOMADA 10A + UM INTERRUPTOR SIMPLES	3/4"	12
	E017212167	LPBPRO6-15 CB PVC BR PRO 1 RJ45 CAT 5E 1 RJ11	UMA TOMADA RJ45 CAT 5E + UMA TOMADA RJ11	3/4"	12
	E017212170	LPBPRO6-15 CB PVC BR PRO 2 T 10A	DUAS TOMADAS 10A	3/4"	12
	E017212171	LPBPRO6-15 CB PVC BR PRO 2 INT SIM	DOIS INTERRUPTORES SIMPLES	3/4"	12
	E017212172	LPBPRO6-15 CB PVC BR PRO 1 T 20A 1 INT SIM	UMA TOMADA 20A + UM INTERRUPTOR SIMPLES	3/4"	12
	E017212176	LPBPRO6-15 CB PVC BR PRO 2 T 20A	DUAS TOMADAS 20A	3/4"	12
	E017212177	LPBPRO6-15 CB PVC BR PRO 2 RJ45 CAT 5E	DUAS TOMADAS RJ45 CAT 5E	3/4"	12
	E017212202	LPBPRO6-15 CB PVC BR PRO 1 T 10A 1 INT PARAL	UMA TOMADA 10A + UM INTERRUPTOR PARALELO	3/4"	12
	E017212205	LPBPRO6-15 CB PVC BR PRO 1 RJ45 CAT 6 1 RJ11	UMA TOMADA RJ45 CAT 6 + UMA TOMADA RJ11	3/4"	12
	E017212207	LPBPRO6-15 CB PVC BR PRO 2 INT PARAL	DOIS INTERRUPTORES PARALELOS	3/4"	12
	E017212208	LPBPRO6-15 CB PVC BR PRO 1 T 20A 1 INT PARAL	UMA TOMADA 20A + UM INTERRUPTOR PARALELO	3/4"	12
	E017212212	LPBPRO6-15 CB PVC BR PRO 2 RJ45 CAT 6	DUAS TOMADAS RJ45 CAT 6	3/4"	12

COMBO POLIWETZEL®

CAIXA DE DERIVAÇÃO MÓVEL TIPO L COM 2 CONECTORES E 5 TAMPÕES

TAMPA MODULAR (COM 3 MECANISMOS)

	CÓDIGO	REFERÊNCIA	DESCRIÇÃO	BITOLA	QT. EMB.
	E017212162	LPBPRO6-15 CB PVC BR PRO 3 T 10A	TRÊS TOMADAS 10A	3/4"	12
	E017212163	LPBPRO6-15 CB PVC BR PRO 3 INT SIM	TRÊS INTERRUPTORES SIMPLES	3/4"	12
	E017212165	LPBPRO6-15 CB PVC BR PRO 2 T 10A 1 INT SIM	DUAS TOMADAS 10A + UM INTERRUPTOR SIMPLES	3/4"	12
	E017212166	LPBPRO6-15 CB PVC BR PRO 2 INT SIM 1T 10A	DOIS INTERRUPTORES SIMPLES + UMA TOMADA 10A	3/4"	12
	E017212174	LPBPRO6-15 CB PVC BR PRO 2 T 20A 1 INT SIM	DUAS TOMADAS 20A + UM INTERRUPTOR SIMPLES	3/4"	12
	E017212175	LPBPRO6-15 CB PVC BR PRO 2 INT SIM 1 T 20A	DOIS INTERRUPTORES SIMPLES + UMA TOMADA 20A	3/4"	12
	E017212180	LPBPRO6-15 CB PVC BR PRO 3 T 20A	TRÊS TOMADAS 20A	3/4"	12
	E017212201	LPBPRO6-15 CB PVC BR PRO 3 INT PARAL	TRÊS INTERRUPTORES PARALELOS	3/4"	12
	E017212203	LPBPRO6-15 CB PVC BR PRO 2 T 10A 1 INT PARAL	DUAS TOMADAS 10A + UM INTERRUPTOR PARALELO	3/4"	12
	E017212204	LPBPRO6-15 CB PVC BR PRO 2 INT PARAL 1 T 10A	DOIS INTERRUPTORES PARALELOS + UMA TOMADA 10A	3/4"	12
	E017212209	LPBPRO6-15 CB PVC BR PRO 2 T 20A 1 INT PARAL	DUAS TOMADAS 20A + UM INTERRUPTOR PARALELO	3/4"	12
	E017212210	LPBPRO6-15 CB PVC BR PRO 2 INT PARAL 1 T 20A	DOIS INTERRUPTORES PARALELOS + UMA TOMADA 20A	3/4"	12

COMBO POLIWETZEL® PVC BRANCO PRO

COMBO POLIWETZEL®

CAIXA DE DERIVAÇÃO MÓVEL TIPO L COM 2 CONECTORES E 5 TAMPÕES

TAMPA CEGA

	CÓDIGO	REFERÊNCIA	DESCRIÇÃO	BITOLA	QT. EMB.
	E017212181	LPBPRO6-20 CB PVC BR PRO CEGO	TAMPA CEGA	1"	12

TAMPA MODULAR (SEM MECANISMO)

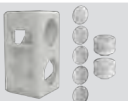
	CÓDIGO	REFERÊNCIA	DESCRIÇÃO	BITOLA	QT. EMB.
	E017212225	LPBPRO6-20 CB PVC BR PRO S/ MÓDULO	TRÊS POSTOS S/ MÓDULO	1"	12

TAMPA MODULAR (COM 1 MECANISMO)

	CÓDIGO	REFERÊNCIA	DESCRIÇÃO	BITOLA	QT. EMB.
	E017212188	LPBPRO6-20 CB PVC BR PRO 1 T 10A	UMA TOMADA 10A	1"	12
	E017212189	LPBPRO6-20 CB PVC BR PRO 1 INT SIM	UM INTERRUPTOR SIMPLES	1"	12
	E017212193	LPBPRO6-20 CB PVC BR PRO 1 T 20A	UMA TOMADA 20A	1"	12
	E017212198	LPBPRO6-20 CB PVC BR PRO 1 RJ45 CAT 5E	UMA TOMADA RJ45 CAT 5E	1"	12
	E017212199	LPBPRO6-20 CB PVC BR PRO 1 RJ11	UMA TOMADA RJ11	1"	12
	E017212220	LPBPRO6-20 CB PVC BR PRO 1 INT PARAL	UM INTERRUPTOR PARALELO	1"	12
	E017212228	LPBPRO6-20 CB PVC BR PRO 1 RJ45 CAT 6	UMA TOMADA RJ45 CAT 6	1"	12
	E017212227	LPBPRO6-20 CB PVC BR PRO 1 USB 5.0V 2.0A	UMA TOMADA USB 5.0V 2.0A	1"	12

COMBO POLIWETZEL® PVC BRANCO PRO

COMBO POLIWETZEL®

CAIXA DE DERIVAÇÃO MÓVEL TIPO L COM 2 CONECTORES E 5 TAMPÕES

TAMPA MODULAR (COM 2 MECANISMOS)

	CÓDIGO	REFERÊNCIA	DESCRIÇÃO	BITOLA	QT. EMB.
	E017212184	LPBPRO6-20 CB PVC BR PRO 1 T 10A 1 INT SIM	UMA TOMADA 10A + UM INTERRUPTOR SIMPLES	1"	12
	E017212187	LPBPRO6-20 CB PVC BR PRO 1 RJ45 CAT 5E 1 RJ11	UMA TOMADA RJ45 CAT 5E + UMA TOMADA RJ11	1"	12
	E017212190	LPBPRO6-20 CB PVC BR PRO 2 T 10A	DUAS TOMADAS 10A	1"	12
	E017212191	LPBPRO6-20 CB PVC BR PRO 2 INT SIM	DOIS INTERRUPTORES SIMPLES	1"	12
	E017212192	LPBPRO6-20 CB PVC BR PRO 1 T 20A 1 INT SIM	UMA TOMADA 20A + UM INTERRUPTOR SIMPLES	1"	12
	E017212196	LPBPRO6-20 CB PVC BR PRO 2 T 20A	DUAS TOMADAS 20A	1"	12
	E017212197	LPBPRO6-20 CB PVC BR PRO 2 RJ45 CAT 5E	DUAS TOMADAS RJ45 CAT 5E	1"	12
	E017212216	LPBPRO6-20 CB PVC BR PRO 1 T 10A 1 INT PARAL	UMA TOMADA 10A + UM INTERRUPTOR PARALELO	1"	12
	E017212219	LPBPRO6-20 CB PVC BR PRO 1 RJ45 CAT 6 1 RJ11	UMA TOMADA RJ45 CAT 6 + UMA TOMADA RJ11	1"	12
	E017212221	LPBPRO6-20 CB PVC BR PRO 2 INT PARAL	DOIS INTERRUPTORES PARALELOS	1"	12
	E017212222	LPBPRO6-20 CB PVC BR PRO 1 T 20A 1 INT PARAL	UMA TOMADA 20A + UM INTERRUPTOR PARALELO	1"	12
	E017212226	LPBPRO6-20 CB PVC BR PRO 2 RJ45 CAT 6	DUAS TOMADAS RJ45 CAT 6	1"	12













COMBO POLIWETZEL® PVC

BRANCO PRO

COMBO POLIWETZEL®

CAIXA DE DERIVAÇÃO MÓVEL TIPO L COM 2 CONECTORES E 5 TAMPÕES

TAMPA MODULAR (COM 3 MECANISMOS)

	CÓDIGO	REFERÊNCIA	DESCRIÇÃO	BITOLA	QT. EMB.
	E017212182	LPBPRO6-20 CB PVC BR PRO 3 T 10A	TRÊS TOMADAS 10A	1"	12
	E017212183	LPBPRO6-20 CB PVC BR PRO 3 INT SIM	TRÊS INTERRUPTORES SIMPLES	1"	12
	E017212185	LPBPRO6-20 CB PVC BR PRO 2 T 10A 1 INT SIM	DUAS TOMADAS 10A + UM INTERRUPTOR SIMPLES	1"	12
	E017212186	LPBPRO6-20 CB PVC BR PRO 2 INT SIM 1T 10A	DOIS INTERRUPTORES SIMPLES + UMA TOMADA 10A	1"	12
	E017212194	LPBPRO6-20CB PVC BR PRO 2 T 20A 1 INT SIM	DUAS TOMADAS 20A + UM INTERRUPTOR SIMPLES	1"	12
	E017212195	LPBPRO6-20 CB PVC BR PRO 2 INT SIM 1 T 20A	DOIS INTERRUPTORES SIMPLES + UMA TOMADA 20A	1"	12
	E017212200	LPBPRO6-20 CB PVC BR PRO 3 T 20A	TRÊS TOMADAS 20A	1"	12
	E017212215	LPBPRO6-20 CB PVC BR PRO 3 INT PARAL	TRÊS INTERRUPTORES PARALELOS	1"	12
	E017212217	LPBPRO6-20 CB PVC BR PRO 2 T 10A 1 INT PARAL	DUAS TOMADAS 10A + UM INTERRUPTOR PARALELO	1"	12
	E017212218	LPBPRO6-20CB PVC BR PRO 2 INT PARAL 1 T 10A	DOIS INTERRUPTORES PARALELOS + UMA TOMADA 10A	1"	12
	E017212223	LPBPRO6-20CB PVC BR PRO 2 T 20A 1 INT PARAL	DUAS TOMADAS 20A + UM INTERRUPTOR PARALELO	1"	12
	E017212224	LPBPRO6-20 CB PVC BR PRO 2 INT PARAL 1 T 20A	DOIS INTERRUPTORES PARALELOS + UMA TOMADA 20A	1"	12

POLIWETZEL[®]

CAIXA DE DERIVAÇÃO MÓVEL

DISPENSA O USO DE PARAFUSOS
TAMPA COM ENCAIXE
RÁPIDO POR PRESSÃO

MULTI ENCAIXE
DIVERSAS COMBINAÇÕES
PARA CONEXÕES EM
ELETRODUTOS

ENCAIXE FUNCIONAL
FACILITA A DESMONTAGEM
E MANUTENÇÃO
DAS INSTALAÇÕES

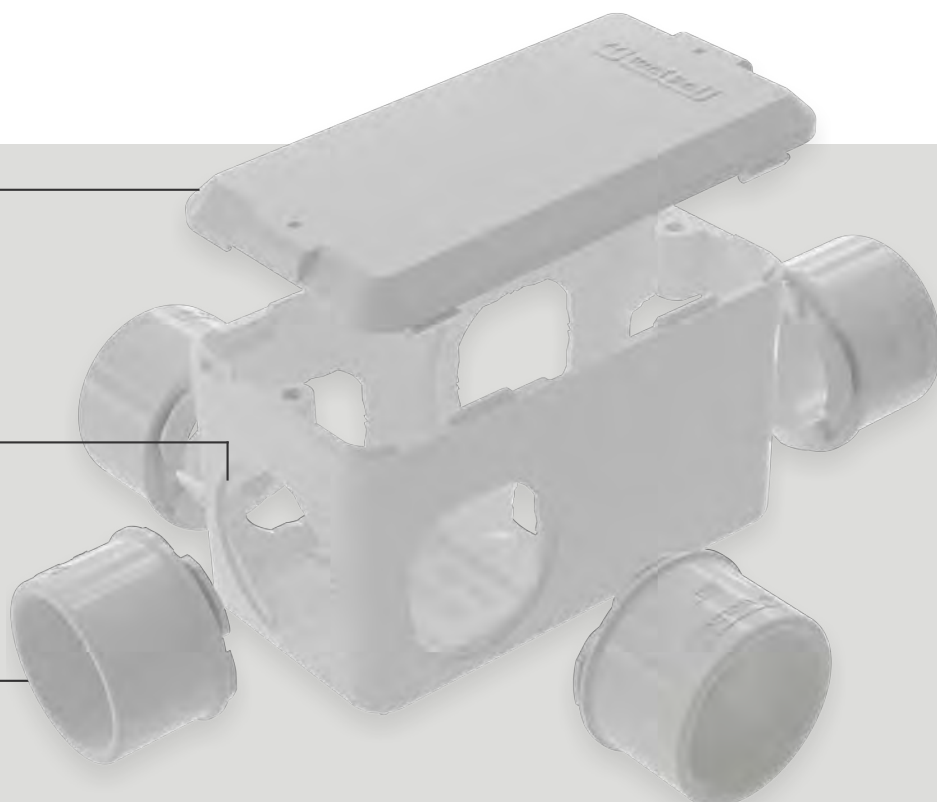

CONHEÇA MAIS SOBRE

- DISPONÍVEL NAS BITOLAS 1/2", 3/4" E 1"

ALTURA DIFERENCIADA
GARANTE MAIS VOLUME INTERNO

PRATICIDADE NA INSTALAÇÃO
E NA PASSAGEM DOS CABOS,
QUE EVITA O ESMAGAMENTO
E REDUZ RISCOS DE CURTOS
CIRCUITOS ELÉTRICOS.

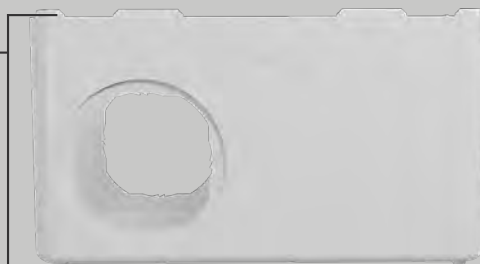

PONTO DE APOIO
MANTÉM DISTÂNCIA DA
SUPERFÍCIE E EVITA O CONTATO
COM A UMIDADE.



CAIXA DE DERIVAÇÃO MÓVEL PEQUENA E ACESSÓRIOS - 1/2" e 3/4"

	CÓDIGO	REFERÊNCIA	DESCRIÇÃO	BITOLA	QT. EMB.
	E017210021	LPBPRO6-10/15 CORPO PVC BR PRO	CORPO E 4 TAMPÕES	1/2" e 3/4"	10
	E019610012	TPIBPRO-10/15 PVC BR PRO	TAMPÃO PARA POLIWETZEL PVC BRANCO PRO 1/2" E 3/4"	1/2" e 3/4"	50
	E020710011	CPBPROL-10 PVC BR PRO	CONECTOR P/ POLIWETZEL PVC BRANCO PRO 1/2"	1/2"	20
	E020710012	CPBPROL-15 PVC BR PRO	CONECTOR P/ POLIWETZEL PVC BRANCO PRO 3/4"	3/4"	20
	E020810011	UNBPRO-10/15 PVC BR PRO	UNIÃO P/ POLIWETZEL PVC BRANCO PRO 1/2" E 3/4"	1/2" e 3/4"	20
	E018010015	TPBPROC-10/15 PVC BR PRO	TAMPA CEGA PVC BRANCO PRO 1/2" E 3/4"	1/2" e 3/4"	10
	E018012850	TPBPROM-55 PVC BR PRO	TAMPA MODULAR TRÊS POSTOS PVC BRANCO PRO 1/2" E 3/4"	1/2" e 3/4"	10

CONECTORES COMPATÍVEIS

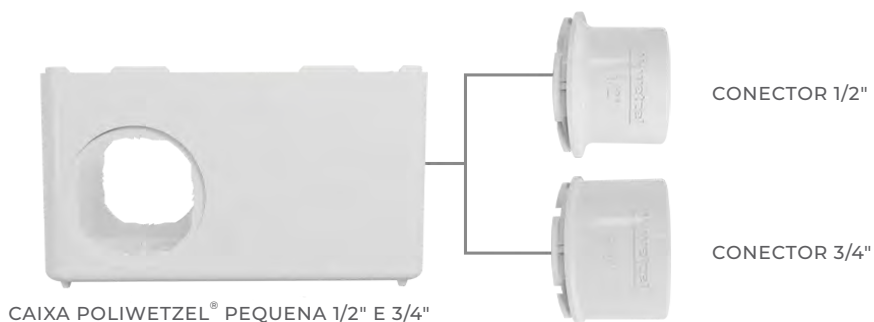

CAIXA DE DERIVAÇÃO MÓVEL GRANDE E ACESSÓRIOS - 1"

	CÓDIGO	REFERÊNCIA	DESCRIÇÃO	BITOLA	QT. EMB.
	E017210022	LPBPRO6-20 CORPO PVC BR PRO	CORPO E 4 TAMPÕES	1"	10
	E019610013	TPIBPRO-20 PVC BR PRO	TAMPÃO PARA POLIWETZEL PVC BRANCO PRO 1"	1"	50
	E020710013	CPBPROL-20 PVC BR PRO	CONECTOR P/ POLIWETZEL PVC BRANCO PRO 1"	1"	20
	E020410011	CPBPROL-10 SU PVC BR PRO	CONECTOR SAÍDAS UNIFICADAS PVC BRANCO PRO 1/2" P/ POLIWETZEL 1"	1/2"	20
	E020410016	CPBPROL-15 SU PVC BR PRO	CONECTOR SAÍDAS UNIFICADAS PVC BRANCO PRO 3/4" P/ POLIWETZEL 1"	3/4"	20
	E020810012	UNBPRO-20 PVC BR PRO	UNIÃO P/ POLIWETZEL PVC BRANCO PRO 1"	1"	20
	E018010016	TPBPROC-20 PVC BR PRO	TAMPA CEGA PVC BRANCO PRO 1"	1"	10
	E018012860	TPBPROM-66 PVC BR PRO	TAMPA MODULAR TRÊS POSTOS PVC BRANCO PRO 1"	1"	10

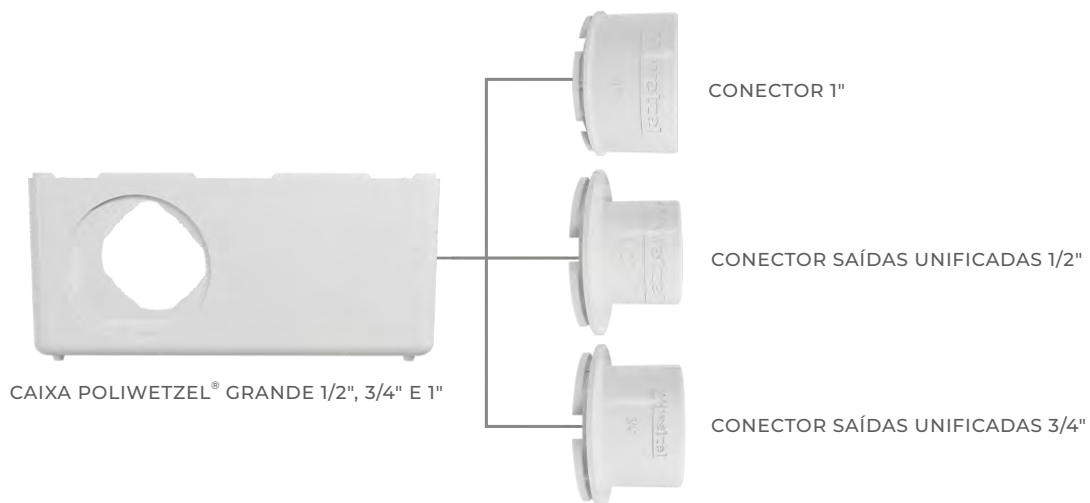

CONECTORES COMPATÍVEIS











A caixa múltipla grande (Poliwetzel®) de 1" é compatível com 3 bitolas, conforme o passo a passo na página 11.

TAMPAS POLIWETZEL® PVC BRANCO PRO

*TAMPA MODULAR

	CÓDIGO	REFERÊNCIA	DESCRIÇÃO	BITOLA	QT. EMB.
	E018012850	TPBPROM-55 PVC BR PRO	TRÊS POSTOS	1/2" e 3/4"	10
	E018012860	TPBPROM-66 PVC BR PRO	TRÊS POSTOS	1"	10

TAMPA MODULAR | TOMADAS RJ

	CÓDIGO	REFERÊNCIA	DESCRIÇÃO	BITOLA	QT. EMB.
	E018012839	TPBPROM-55 PVC BR PRO + MÓDULO P/ RJ45	PARA UMA TOMADA RJ45	1/2" e 3/4"	10
	E018012840	TPBPROM-55 PVC BR PRO + 2 MÓDULOS P/ RJ45	PARA DUAS TOMADAS RJ45	1/2" e 3/4"	10
	E018012841	TPBPROM-55 PVC BR PRO + RJ45 CAT 5E	COM UMA TOMADA RJ45 CAT 5E	1/2" e 3/4"	10
	E018012842	TPBPROM-55 PVC BR PRO + 2 RJ45 CAT 5E	COM DUAS TOMADAS RJ45 CAT 5E	1/2" e 3/4"	10
	E018012862	TPBPROM-66 PVC BR PRO + MÓDULO P/ RJ45	PARA UMA TOMADA RJ45	1"	10
	E018012863	TPBPROM-66 PVC BR PRO + 2 MÓDULOS P/ RJ45	PARA DUAS TOMADAS RJ45	1"	10
	E018012864	TPBPROM-66 PVC BR PRO + RJ45 CAT 5E	COM UMA TOMADA RJ45 CAT 5E	1"	10
	E018012865	TPBPROM-66 PVC BR PRO + 2 RJ45 CAT 5E	COM DUAS TOMADAS RJ45 CAT 5E	1"	10

*As tampas modulares foram projetadas para acompanhar os módulos Wetzel da Linha Industrie.

LINHA INDUSTRIE MECANISMOS MODULARES



MÓDULOS WETZEL

ESPECIALMENTE DESENVOLVIDOS PARA AS TAMPAS MODULARES DE POLIWETZEL.

Disponíveis nas páginas 137 e 138



TAMPA CEGA

	CÓDIGO	REFERÊNCIA	DESCRIÇÃO	BITOLA	QT. EMB.
	E018010015	TPBPROC-10/15 PVC BR PRO	CEGA	1/2" e 3/4"	10
	E018010016	TPBPROC-20 PVC BR PRO	CEGA	1"	10

TAMPA MONOBLOCO

	CÓDIGO	REFERÊNCIA	DESCRIÇÃO	BITOLA	QT. EMB.
	E018010123	TPBPROA-01 PVC BR PRO	PARA UM INTERRUPTOR VERTICAL	1/2" e 3/4"	10
	E018010133	*TPBPROA-02 PVC BR PRO	PARA DOIS INTERRUPTORES HORIZONTAIS JUNTOS	1/2" e 3/4"	10
	E018010143	TPBPROA-03 PVC BR PRO	PARA TRÊS INTERRUPTORES HORIZONTAIS JUNTOS	1/2" e 3/4"	10
	E018010153	TPBPROA-04 PVC BR PRO	PARA DOIS INTERRUPTORES HORIZONTAIS SEPARADOS	1/2" e 3/4"	10
	E018010163	TPBPROA-05 PVC BR PRO	PARA UMA TOMADA REDONDA	1/2" e 3/4"	10
	E018012818	TPBPROA-35 PVC BR PRO	PARA UMA TOMADA HEXAGONAL VERTICAL	1/2" e 3/4"	10
	E018010283	TPBPROA-12 PVC BR PRO	PARA UM INTERRUPTOR VERTICAL	1"	10
	E018010293	*TPBPROA-13 PVC BR PRO	PARA DOIS INTERRUPTORES HORIZONTAIS JUNTOS	1"	10

TAMPAS POLIWETZEL® PVC BRANCO PRO

TAMPA MONOBLOCO

	CÓDIGO	REFERÊNCIA	DESCRIÇÃO	BITOLA	QT. EMB.
	E018010303	TPBPROA-14 PVC BR PRO	PARA TRÊS INTERRUPTORES HORIZONTAIS JUNTOS	1"	10
	E018010313	TPBPROA-15 PVC BR PRO	PARA DOIS INTERRUPTORES HORIZONTAIS SEPARADOS	1"	10
	E018010017	TPBPROA-16 PVC BR PRO	PARA UMA TOMADA REDONDA	1"	10
	E018010018	TPBPROA-17 PVC BR PRO	PARA UMA TOMADA REDONDA	1"	10
	E018010403	TPBPROA-24 PVC BR PRO	PARA DUAS TOMADAS REDONDAS	1"	10
	E018012819	TPBPROA-36 PVC BR PRO	PARA DUAS TOMADAS HEXAGONAIS HORIZONTAIS SEPARADAS	1"	10
	E018012820	TPBPROA-37 PVC BR PRO	PARA UM INTERRUPTOR E UMA TOMADA HEXAGONAL SEPARADOS	1"	10
	E018012821	TPBPROA-38 PVC BR PRO	PARA DOIS INTERRUPTORES JUNTOS E UMA TOMADA HEXAGONAL HORIZONTAL SEPARADA	1"	10

MECANISMO MONOBLOCO (SOB CONSULTA)

	CÓDIGO	REFERÊNCIA	DESCRIÇÃO	COR	QT. EMB.
	E020900041	INT BI 10A/250V~	INTERRUPTOR BIPOLAR (SIMPLES/PARALELO) 10A-250V~	BRANCO	25

*COMPATÍVEL COM A TAMPA TPBA-02 E TPBA-13, PÁGINA 111.

CONHEÇA NOSSA LINHA **EX**



ACESSE E BAIXE



www.WETZEL.com.br



TUBOS E ACESSÓRIOS



CONHEÇA MAIS SOBRE

TUBOS

- **ELETROWETZEL PLASTIK MAX**
VERSATILIDADE E CUSTO-BENEFÍCIO PARA AMBIENTES **COMERCIAIS**
- **ELETROWETZEL PLASTIK STANDARD**
QUALIDADE PARA AMBIENTES **RESIDENCIAIS** E/OU COM FINALIDADE **DECORATIVA**



ELETROWETZEL PLASTIK MAX (SEM ROSCA)

	CÓDIGO	REFERÊNCIA	DESCRIÇÃO	ESPESSURA (mm)	BITOLA	QT. EMB.
	E020310211	EMBPRO-10 PVC BR PRO	ELETROWETZEL RÍGIDO PLASTIK MAX PVC BRANCO PRO 1/2"	1,5	1/2"	20
	E020310212	EMBPRO-15 PVC BR PRO	ELETROWETZEL RÍGIDO PLASTIK MAX PVC BRANCO PRO 3/4"	1,5	3/4"	20
	E020310213	EMBPRO-20 PVC BR PRO	ELETROWETZEL RÍGIDO PLASTIK MAX PVC BRANCO PRO 1"	1,7	1"	10

ELETROWETZEL PLASTIK STANDARD (SEM ROSCA)

	CÓDIGO	REFERÊNCIA	DESCRIÇÃO	ESPESSURA (mm)	BITOLA	QT. EMB.
	E020310011	ESBPRO-10 PVC BR PRO	ELETROWETZEL RÍGIDO PLASTIK STANDARD PVC BRANCO PRO 1/2"	1,2	1/2"	20
	E020310012	ESBPRO-15 PVC BR PRO	ELETROWETZEL RÍGIDO PLASTIK STANDARD PVC BRANCO PRO 3/4"	1,2	3/4"	20
	E020310013	ESBPRO-20 PVC BR PRO	ELETROWETZEL RÍGIDO PLASTIK STANDARD PVC BRANCO PRO 1"	1,4	1"	10

ACESSÓRIOS PVC BRANCO PRO



ABRAÇADEIRA

	CÓDIGO	REFERÊNCIA	DESCRIÇÃO	BITOLA	QT. EMB.
	E015510011	ABBPRO-10 PP BR PRO	ABRAÇADEIRA BRANCO PRO 1/2"	1/2"	50
	E015510012	ABBPRO-15 PP BR PRO	ABRAÇADEIRA BRANCO PRO 3/4"	3/4"	50
	E015510013	ABBPRO-20 PP BR PRO	ABRAÇADEIRA BRANCO PRO 1"	1"	50

LUVA (SEM ROSCA)

	CÓDIGO	REFERÊNCIA	DESCRIÇÃO	BITOLA	QT. EMB.
	E015210011	LBPRO-10 PVC BR PRO	LUVA SEM ROSCA BRANCO PRO 1/2"	1/2"	20
	E015210012	LBPRO-15 PVC BR PRO	LUVA SEM ROSCA BRANCO PRO 3/4"	3/4"	20
	E015210013	LBPRO-20 PVC BR PRO	LUVA SEM ROSCA BRANCO PRO 1"	1"	20

BUCHA DE REDUÇÃO (SEM ROSCA)

	CÓDIGO	REFERÊNCIA	DESCRIÇÃO	BITOLA	QT. EMB.
	E015410011	BRBPRO-15/10 PVC BR PRO	BUCHA DE REDUÇÃO SEM ROSCA BRANCO PRO 3/4x1/2"	3/4" X 1/2"	20
	E015410012	BRBPRO-20/15 PVC BR PRO	BUCHA DE REDUÇÃO SEM ROSCA BRANCO PRO 1x3/4"	1" X 3/4"	20

APLICAÇÃO DE BUCHA DE REDUÇÃO EM CAIXA FIXA



CURVA COM 90° PLASTIK MAX (COM DUAS BOLSAS)

	CÓDIGO	REFERÊNCIA	DESCRIÇÃO	BITOLA	QT. EMB.
	E020110012	C90BPRO-10 PVC BR PRO	CURVA 90° C/ 2 BOLSAS BRANCO PRO 1/2"	1/2"	10
	E020110013	C90BPRO-15 PVC BR PRO	CURVA 90° C/ 2 BOLSAS BRANCO PRO 3/4"	3/4"	10
	E020110014	C90BPRO-20 PVC BR PRO	CURVA 90° C/ 2 BOLSAS BRANCO PRO 1"	1"	10

CURVA COM 90° PLASTIK STANDARD (COM DUAS BOLSAS)

	CÓDIGO	REFERÊNCIA	DESCRIÇÃO	BITOLA	QT. EMB.
	E020111011	CS90BPRO-10 PVC BR PRO	CURVA STANDARD 90° C/ 2 BOLSAS BRANCO PRO 1/2"	1/2"	10
	E020111012	CS90BPRO-15 PVC BR PRO	CURVA STANDARD 90° C/ 2 BOLSAS BRANCO PRO 3/4"	3/4"	10
	E020111013	CS90BPRO-20 PVC BR PRO	CURVA STANDARD 90° C/ 2 BOLSAS BRANCO PRO 1"	1"	10

COTOVELO COM 90° (COM TAMPA VIGIA SEM ROSCA)

	CÓDIGO	REFERÊNCIA	DESCRIÇÃO	BITOLA	QT. EMB.
	E015310011	CBPRO-10 PVC BR PRO	COTOVELO COM TAMPA VIGIA EM PVC SEM ROSCA BRANCO PRO 1/2"	1/2"	20
	E015310012	CBPRO-15 PVC BR PRO	COTOVELO COM TAMPA VIGIA EM PVC SEM ROSCA BRANCO PRO 3/4"	3/4"	20
	E015310013	CBPRO-20 PVC BR PRO	COTOVELO COM TAMPA VIGIA EM PVC SEM ROSCA BRANCO PRO 1"	1"	20

LINHA VERMELHO

Indicada para instalações de sistemas de alarme
contra incêndio, de acordo com a norma NBR6493.



Não propaga
chamas



Não conduz
eletricidade



Praticidade
no encaixe



Apta para
reciclagem



COMBOS POLIWETZEL®

PÁGINAS
120 a 121



POLI WETZEL®

PÁGINAS
122 a 126



CONDULETZEL®

PÁGINAS
127 a 130

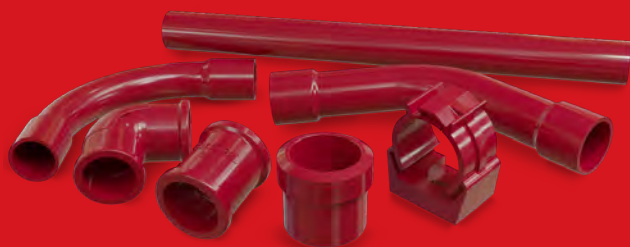

ELETRODUTOS, TUBOS E ACESSÓRIOS

PÁGINAS
131 a 135

COMBOS POLIWETZEL®

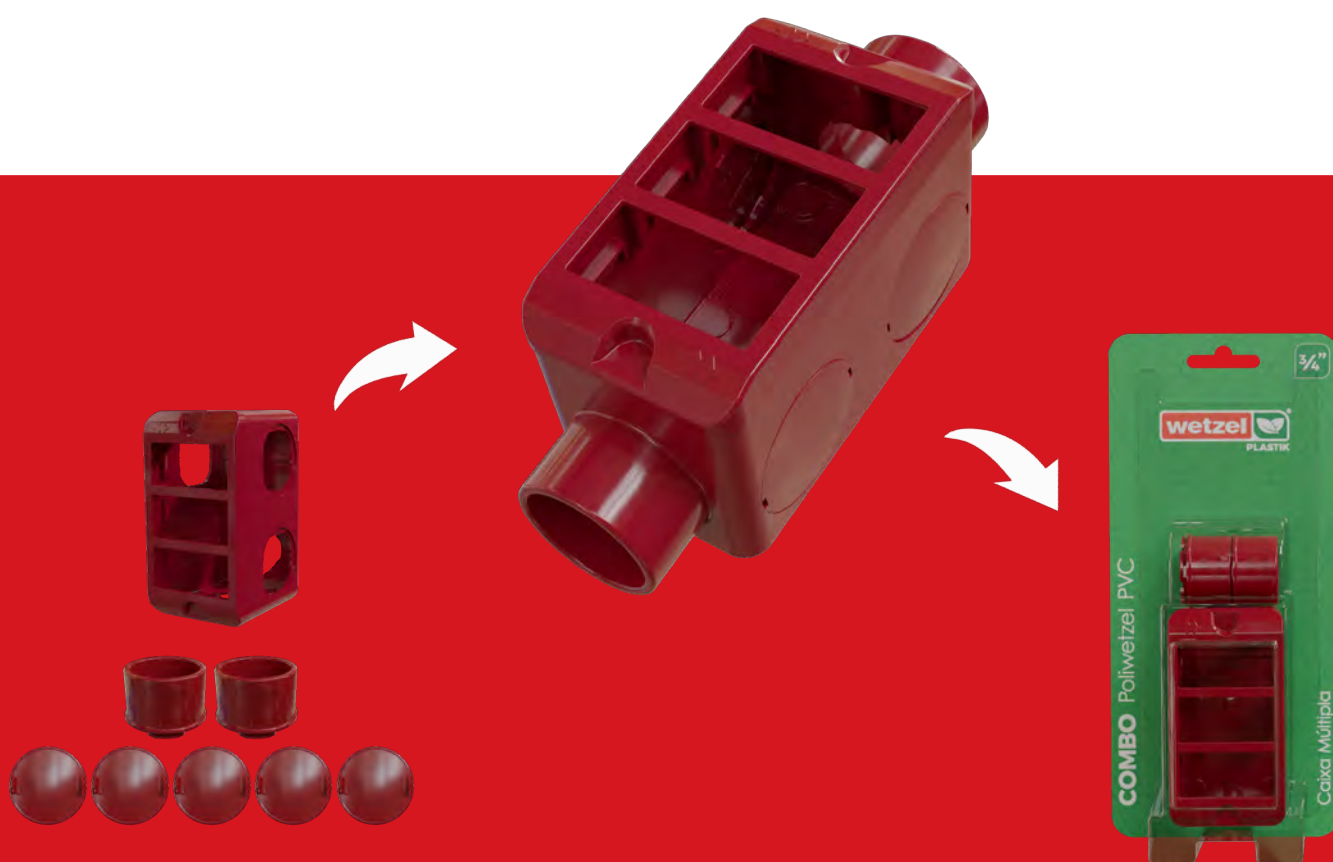

CONHEÇA OS COMBOS

- DISPONÍVEIS NAS BITOLAS 3/4" E 1"
- PRÁTICOS PARA **ARMAZENAR E PREPARAR** INSTALAÇÕES



COMBO POLIWETZEL® PVC VERMELHO

COMBO POLIWETZEL®

CAIXA DE DERIVAÇÃO MÓVEL TIPO L COM 2 CONECTORES e 5 TAMPÕES

TAMPA CEGA

	CÓDIGO	REFERÊNCIA	DESCRIÇÃO	BITOLA	QT. EMB.
	E017222020	LPV6-15 CB PVC VM CEGO	TAMPA CEGA	3/4"	12

TAMPA MODULAR (SEM MECANISMO)

	CÓDIGO	REFERÊNCIA	DESCRIÇÃO	BITOLA	QT. EMB.
	E017222135	LPV6-15 CB PVC VM S/MÓDULO	TAMPA TRÊS POSTOS SEM MÓDULOS	3/4"	12

COMBO POLIWETZEL®

CAIXA DE DERIVAÇÃO MÓVEL TIPO L COM 2 CONECTORES e 5 TAMPÕES

TAMPA CEGA

	CÓDIGO	REFERÊNCIA	DESCRIÇÃO	BITOLA	QT. EMB.
	E017222040	LPV6-20 CB PVC VM CEGO	TAMPA CEGA	1"	12

TAMPA MODULAR (SEM MECANISMO)

	CÓDIGO	REFERÊNCIA	DESCRIÇÃO	BITOLA	QT. EMB.
	E017222155	LPV6-20 CB PVC VM S/MÓDULO	TAMPA TRÊS POSTOS SEM MÓDULOS	1"	12

LINHA INDUSTRIE
MECANISMOS MODULARES

MÓDULOS WETZEL
COMPATÍVEIS COM OS COMBOS POLIWETZEL.



Disponíveis nas páginas 137 e 138

POLIWETZEL[®]

CAIXA DE DERIVAÇÃO MÓVEL

DISPENSA O USO DE PARAFUSOS
TAMPA COM ENCAIXE
RÁPIDO POR PRESSÃO

MULTI ENCAIXE
DIVERSAS COMBINAÇÕES
PARA CONEXÕES EM
ELETRODUTOS

ENCAIXE FUNCIONAL
FACILITA A DESMONTAGEM
E MANUTENÇÃO
DAS INSTALAÇÕES

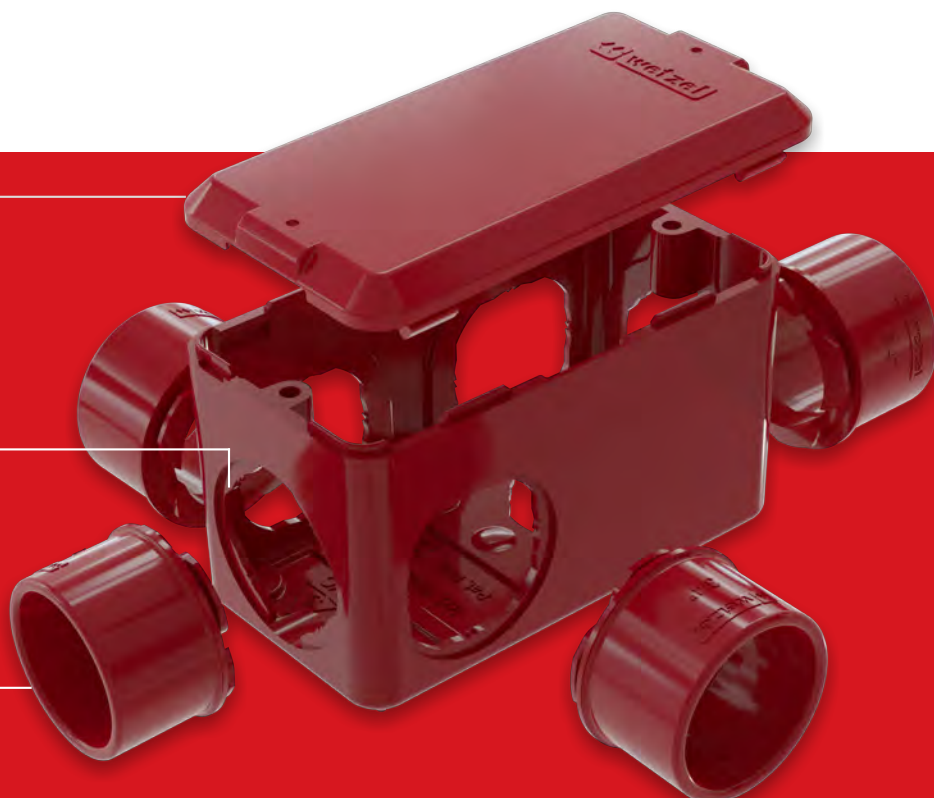

CONHEÇA MAIS SOBRE

- DISPONÍVEL NAS BITOLAS 1/2", 3/4" E 1"

ALTURA DIFERENCIADA
GARANTE MAIS VOLUME INTERNO

PRATICIDADE NA INSTALAÇÃO
E NA PASSAGEM DOS CABOS,
QUE EVITA O ESMAGAMENTO
E REDUZ RISCOS DE CURTOS
CIRCUITOS ELÉTRICOS.



PONTO DE APOIO
MANTÉM DISTÂNCIA DA
SUPERFÍCIE E EVITA CONTATO
COM A UMIDADE.









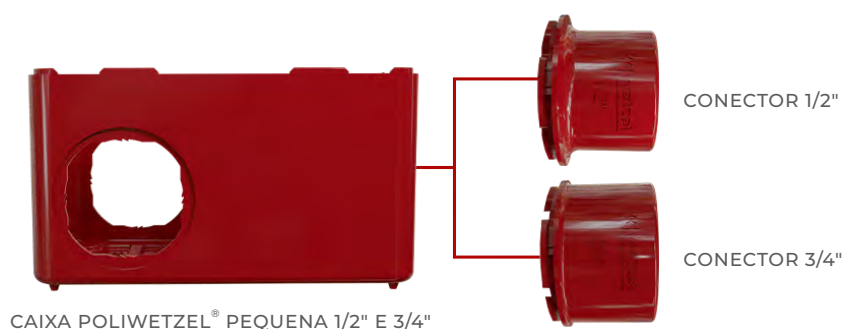

CAIXA DE DERIVAÇÃO MÓVEL PEQUENA E ACESSÓRIOS - 1/2" E 3/4"

	CÓDIGO	REFERÊNCIA	DESCRIÇÃO	BITOLA	QT. EMB.
	E017220020	LPV6-10/15 CORPO PVC VM	CORPO E 4 TAMPÕES	1/2" e 3/4"	10
	E019630010	TPIV-10/15 PVC VM	TAMPÃO P/ POLIWETZEL PVC VERMELHO 1/2" E 3/4"	1/2" e 3/4"	50
	E020730010	CPVL-10 PVC VM	CONECTOR P/ POLIWETZEL PVC VERMELHO 1/2"	1/2"	20
	E020730015	CPVL-15 PVC VM	CONECTOR P/ POLIWETZEL PVC VERMELHO 3/4"	3/4"	20
	E020830010	UNV-10/15 PVC VM	UNIÃO P/ POLIWETZEL PVC VERMELHO 1/2" E 3/4"	1/2" e 3/4"	20
	E018030012	TPVC-10/15 PVC VM	TAMPA CEGA PVC VERMELHA 1/2" E 3/4"	1/2" e 3/4"	10
	E018032844	TPVM-55 PVC VM	TAMPA MODULAR TRÊS POSTOS PVC VERMELHA 1/2" E 3/4"	1/2" e 3/4"	10

CONECTORES COMPATÍVEIS



CAIXA DE DERIVAÇÃO MÓVEL PEQUENA E ACESSÓRIOS - 1/2", 3/4" E 1"

	CÓDIGO	REFERÊNCIA	DESCRIÇÃO	BITOLA	QT. EMB.
	E017220040	LPV6-20 CORPO PVC VM	CORPO E 4 TAMPÕES	1"	10
	E019630020	TPIV-20 PVC VM	TAMPÃO P/ POLIWETZEL PVC VERMELHO 1"	1"	50
	E020730020	CPVL-20 PVC VM	CONECTOR P/ POLIWETZEL PVC VERMELHO 1"	1"	20
	E020430010	CPVL-10 SU PVC VM	CONECTOR SAÍDAS UNIFICADAS PVC VERMELHO 1/2" P/ POLIWETZEL 1"	1/2"	20
	E020430015	CPVL-15 SU PVC VM	CONECTOR SAÍDAS UNIFICADAS PVC VERMELHO 3/4" P/ POLIWETZEL 1"	3/4"	20
	E020830020	UNV-20 PVC VM	UNIÃO P/ POLIWETZEL PVC VERMELHO 1"	1"	20
	E018030032	TPVC-20 PVC VM	TAMPA CEGA PVC VERMELHA 1"	1"	10
	E018032854	TPVM-66 PVC VM	TAMPA MODULAR TRÊS POSTOS PVC VERMELHA 1"	1"	10

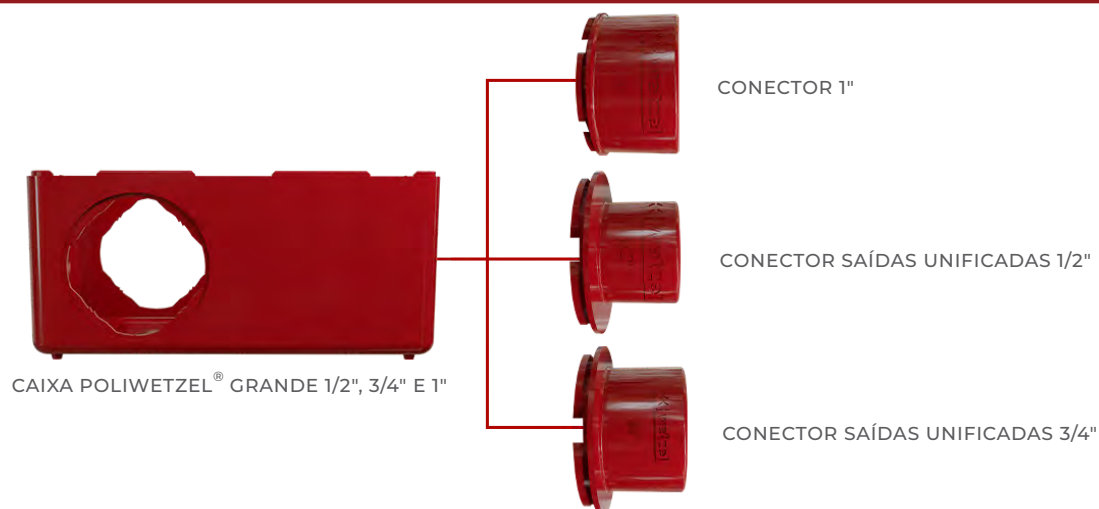

CONECTORES COMPATÍVEIS











A caixa múltipla grande (Poliwetzl®) de 1" é compatível com 3 bitolas, conforme o passo a passo na página 11.

TAMPAS PARA POLIWETZEL® PVC VERMELHO

*TAMPA MODULAR

	CÓDIGO	REFERÊNCIA	DESCRIÇÃO	BITOLA	QT. EMB.
	E018032844	TPVM-55 PVC VM	TRÊS POSTOS	1/2" e 3/4"	10
	E018032854	TPVM-66 PVC VM	TRÊS POSTOS	1"	10

TAMPA MODULAR | TOMADAS RJ

	CÓDIGO	REFERÊNCIA	DESCRIÇÃO	BITOLA	QT. EMB.
	E018032846	TPVM-55 PVC VM + MÓDULO P/ RJ45	PARA UMA TOMADA RJ45	1/2" e 3/4"	10
	E018032847	TPVM-55 PVC VM + 2 MÓDULOS P/ RJ45	PARA DUAS TOMADAS RJ45	1/2" e 3/4"	10
	E018032848	TPVM-55 PVC VM + RJ45 CAT 5E	COM UMA TOMADA RJ45 CAT 5E	1/2" e 3/4"	10
	E018032849	TPVM-55 PVC VM + 2 RJ45 CAT 5E	COM DUAS TOMADAS RJ45 CAT 5E	1/2" e 3/4"	10
	E018032856	TPVM-66 PVC VM + MÓDULO P/ RJ45	PARA UMA TOMADA RJ45	1"	10
	E018032857	TPVM-66 PVC VM + 2 MÓDULOS P/ RJ45	PARA DUAS TOMADAS RJ45	1"	10
	E018032858	TPVM-66 PVC VM + RJ45 CAT 5E	COM UMA TOMADA RJ45 CAT 5E	1"	10
	E018032859	TPVM-66 PVC VM + 2 RJ45 CAT 5E	COM DUAS TOMADAS RJ45 CAT 5E	1"	10

*As tampas modulares foram projetadas para acompanhar os módulos Wetzel da Linha Industrie.

LINHA INDUSTRIE MECANISMOS MODULARES

MÓDULOS WETZEL

ESPECIALMENTE DESENVOLVIDOS PARA AS TAMPAS MODULARES DE POLIWETZEL E CONDULETZEL.

Disponíveis nas páginas 137 e 138



TAMPAS PARA POLIWETZEL® PVC VERMELHO

TAMPA CEGA

	CÓDIGO	REFERÊNCIA	DESCRIÇÃO	BITOLA	QT. EMB.
	E018030012	TPVC-10/15 PVC VM	CEGA	1/2" e 3/4"	10
	E018030032	TPVC-20 PVC VM	CEGA	1"	10

TAMPA MONOBLOCO

	CÓDIGO	REFERÊNCIA	DESCRIÇÃO	BITOLA	QT. EMB.
	E018030132	*TPVA-02 PVC VM	PARA DOIS INTERRUPTORES HORIZONTAIS JUNTOS	1/2" e 3/4"	10
	E018030142	TPVA-03 PVC VM	PARA TRÊS INTERRUPTORES HORIZONTAIS JUNTOS	1/2" e 3/4"	10
	E018030162	TPVA-05 PVC VM	PARA UMA TOMADA REDONDA	1/2" e 3/4"	10
	E018032814	TPVA-35 PVC VM	PARA UMA TOMADA HEXAGONAL VERTICAL	1/2" e 3/4"	10
	E018030302	TPVA-14 PVC VM	PARA TRÊS INTERRUPTORES HORIZONTAIS JUNTOS	1"	10
	E018030013	TPVA-16 PVC VM	PARA UMA TOMADA REDONDA	1"	10
	E018032815	TPVA-36 PVC VM	PARA DUAS TOMADAS HEXAGONAIS HORIZONTAIS SEPARADAS	1"	10
	E018032816	TPVA-37 PVC VM	PARA UM INTERRUPTOR E UMA TOMADA HORIZONTAL SEPARADOS	1"	10
	E018032817	TPVA-38 PVC VM	PARA DOIS INTERRUPTORES JUNTOS E UMA TOMADA HEXAGONAL HORIZONTAL SEPARADA	1"	10

MECANISMO MONOBLOCO (SOB CONSULTA)

	CÓDIGO	REFERÊNCIA	DESCRIÇÃO	COR	QT. EMB.
	E020900041	INT BI 10A/250V~	INTERRUPTOR BIPOLAR (SIMPLES/ PARALELO) 10A-250V~	BRANCO	25

*COMPATÍVEL COM A TAMPA TPVA-02, PÁGINA 126.

CONDULETZEL[®]

CAIXA DE DERIVAÇÃO FIXA

ACOMPANHA PARAFUSOS
COM TRATAMENTO ESPECIAL

SEM ROSCA
CONEXÃO POR
MEIO DE ENCAIXE



CONHEÇA MAIS SOBRE

- DISPONÍVEL NAS BITOLAS 1/2", 3/4" E 1"
- DIVERSAS COMBINAÇÕES PARA CONEXÕES EM ELETRODUTOS

MODELOS DISPONÍVEIS:



C



E



LB



LL



LR



T



TB

















X



CONDULETZEL® PVC VERMELHO

CAIXA DE DERIVAÇÃO FIXA

	CÓDIGO	REFERÊNCIA	DESCRIÇÃO	TIPO	BITOLA	QT. EMB.
	E013023021	CVSR-10 CORPO PVC VM	CAIXA FIXA CONDULETZEL VM TIPO C 1/2" S/ TP S/ VED S/ R	C	1/2"	5
	E013033021	EVSR-10 CORPO PVC VM	CAIXA FIXA CONDULETZEL VM TIPO E 1/2" S/ TP S/ VED S/ R	E	1/2"	5
	E013043021	LBVSR-10 CORPO PVC VM	CAIXA FIXA CONDULETZEL VM TIPO LB 1/2" S/ TP S/ VED S/ R	LB	1/2"	5
	E013053021	LLVSR-10 CORPO PVC VM	CAIXA FIXA CONDULETZEL VM TIPO LL 1/2" S/ TP S/ VED S/ R	LL	1/2"	5
	E013063021	LRVSR-10 CORPO PVC VM	CAIXA FIXA CONDULETZEL VM TIPO LR 1/2" S/ TP S/ VED S/ R	LR	1/2"	5
	E013073021	TVSR-10 CORPO PVC VM	CAIXA FIXA CONDULETZEL VM TIPO T 1/2" S/ TP S/ VED S/ R	T	1/2"	5
	E013093021	TBVSR-10 CORPO PVC VM	CAIXA FIXA CONDULETZEL VM TIPO TB 1/2" S/ TP S/ VED S/ R	TB	1/2"	5
	E013103021	XVSR-10 CORPO PVC VM	CAIXA FIXA CONDULETZEL VM TIPO X 1/2" S/ TP S/ VED S/ R	X	1/2"	5
	E013023031	CVSR-15 CORPO PVC VM	CAIXA FIXA CONDULETZEL VM TIPO C 3/4" S/ TP S/ VED S/ R	C	3/4"	5
	E013033031	EVSR-15 CORPO PVC VM	CAIXA FIXA CONDULETZEL VM TIPO E 3/4" S/ TP S/ VED S/ R	E	3/4"	5
	E013043031	LBVSR-15 CORPO PVC VM	CAIXA FIXA CONDULETZEL VM TIPO LB 3/4" S/ TP S/ VED S/ R	LB	3/4"	5
	E013053031	LLVSR-15 CORPO PVC VM	CAIXA FIXA CONDULETZEL VM TIPO LL 3/4" S/ TP S/ VED S/ R	LL	3/4"	5
	E013063031	LRVSR-15 CORPO PVC VM	CAIXA FIXA CONDULETZEL VM TIPO LR 3/4" S/ TP S/ VED S/ R	LR	3/4"	5
	E013073031	TVSR-15 CORPO PVC VM	CAIXA FIXA CONDULETZEL VM TIPO T 3/4" S/ TP S/ VED S/ R	T	3/4"	5
	E013093031	TBVSR-15 CORPO PVC VM	CAIXA FIXA CONDULETZEL VM TIPO TB 3/4" S/ TP S/ VED S/ R	TB	3/4"	5

CAIXA DE DERIVAÇÃO FIXA









	CÓDIGO	REFERÊNCIA		TIPO	BITOLA	QT. EMB.
	E013103031	XVSR-15 CORPO PVC VM	CAIXA FIXA CONDULETZEL VM TIPO X 3/4" S/ TP S/ VED S/ R	X	3/4"	5
	E013023041	CVSR-20 CORPO PVC VM	CAIXA FIXA CONDULETZEL VM TIPO C 1" S/ TP S/ VED S/ R	C	1"	5
	E013033041	EVSR-20 CORPO PVC VM	CAIXA FIXA CONDULETZEL VM TIPO E 1" S/ TP S/ VED S/ R	E	1"	5
	E013043041	LBVSR-20 CORPO PVC VM	CAIXA FIXA CONDULETZEL VM TIPO LB 1" S/ TP S/ VED S/ R	LB	1"	5
	E013053041	LLVSR-20 CORPO PVC VM	CAIXA FIXA CONDULETZEL VM TIPO LL 1" S/ TP S/ VED S/ R	LL	1"	5
	E013063041	LRVSR-20 CORPO PVC VM	CAIXA FIXA CONDULETZEL VM TIPO LR 1" S/ TP S/ VED S/ R	LR	1"	5
	E013073041	TVSR-20 CORPO PVC VM	CAIXA FIXA CONDULETZEL VM TIPO T 1" S/ TP S/ VED S/ R	T	1"	5
	E013093041	TBVSR-20 CORPO PVC VM	CAIXA FIXA CONDULETZEL VM TIPO TB 1" S/ TP S/ VED S/ R	TB	1"	5
	E013103041	XVSR-20 CORPO PVC VM	CAIXA FIXA CONDULETZEL VM TIPO X 1" S/ TP S/ VED S/ R	X	1"	5

*TAMPA MODULAR

	CÓDIGO	REFERÊNCIA	DESCRIÇÃO	BITOLA	QT. EMB.
	E014032844	TCVM-55 PVC VM	TRÊS POSTOS	1/2" e 3/4"	10
	E014032854	TCVM-66 PVC VM	TRÊS POSTOS	1"	10

TAMPAS PARA CONDULETZEL® PVC VERMELHO

TAMPA MODULAR | TOMADAS RJ

	CÓDIGO	REFERÊNCIA	DESCRIÇÃO	BITOLA	QT. EMB.
	E014032846	TCVM-55 PVC VM + MÓDULO P/ RJ45	PARA UMA TOMADA RJ45	1/2" e 3/4"	10
	E014032847	TCVM-55 PVC VM + 2 MÓDULOS P/RJ45	PARA DUAS TOMADAS RJ45	1/2" e 3/4"	10
	E014032848	TCVM-55 PVC VM + RJ45 CAT 5E	COM UMA TOMADA RJ45 CAT 5E	1/2" e 3/4"	10
	E014032849	TCVM-55 PVC VM + 2 RJ45 CAT 5E	COM DUAS TOMADAS RJ45 CAT 5E	1/2" e 3/4"	10
	E014032856	TCVM-66 PVC VM + MÓDULO P/ RJ45	PARA UMA TOMADA RJ45	1"	10
	E014032857	TCVM-66 PVC VM + 2 MÓDULOS P/ RJ45	PARA DUAS TOMADAS RJ45	1"	10
	E014032858	TCVM-66 PVC VM + RJ45 CAT 5E	COM UMA TOMADA RJ45 CAT 5E	1"	10
	E014032859	TCVM-66 PVC VM + 2 RJ45 CAT 5E	COM DUAS TOMADAS RJ45 CAT 5E	1"	10

*As tampas modulares foram projetadas para acompanhar os módulos Wetzel da Linha Industrie.

LINHA INDUSTRIE MECANISMOS MODULARES



MÓDULOS WETZEL

ESPECIALMENTE DESENVOLVIDOS PARA AS TAMPAS
MODULARES DE POLI**WETZEL** E CONDU**LETZEL**.

Disponíveis nas páginas 137 e 138



TAMPA CEGA

	CÓDIGO	REFERÊNCIA	DESCRIÇÃO	BITOLA	QT. EMB.
	E014030012	TCVC-10/15 PVC VM	CEGA	1/2" e 3/4"	10
	E014030032	TCVC-20 PVC VM	CEGA	1"	10

ELETRODUTOS, TUBOS E ACESSÓRIOS



CONHEÇA MAIS SOBRE

ELETRODUTOS

- **ELETRODUTO PLASTIK CLASSE A**
PAREDE EXTRA PARA AMBIENTES INDUSTRIAIS E/OU SUJEITOS À GRANDES SOLICITAÇÕES MECÂNICAS
- **ELETRODUTO PLASTIK PESADO**
SEGURANÇA PARA INSTALAÇÕES PROFISSIONAIS EM AMBIENTES INDUSTRIAIS

TUBOS

- **ELETROWETZEL PLASTIK MAX**
VERSATILIDADE E CUSTO-BENEFÍCIO PARA AMBIENTES COMERCIAIS
- **ELETROWETZEL PLASTIK STANDARD**
QUALIDADE PARA AMBIENTES RESIDENCIAIS E/OU COM FINALIDADE DECORATIVA



ELETRODUTO E TUBOS PVC VERMELHO

ELETRODUTOS

ELETRODUTO PLASTIK CLASSE A (SEM ROSCA)



	CÓDIGO	REFERÊNCIA	DESCRIÇÃO	ESPESSURA (mm)	BITOLA	QT. EMB.
	E020330315	EAV-15 PVC VM	ELETRODUTO RÍGIDO CLASSE A PVC VERMELHO 3/4"	2,6	3/4"	20
	E020330320	EAV-20 PVC VM	ELETRODUTO RÍGIDO CLASSE A PVC VERMELHO 1"	3,2	1"	10

ELETRODUTO PLASTIK PESADO (SEM ROSCA)

	CÓDIGO	REFERÊNCIA	DESCRIÇÃO	ESPESSURA (mm)	BITOLA	QT. EMB.
	E020330010	EPV-10 PVC VM	ELETRODUTO RÍGIDO PESADO PVC VERMELHO 1/2"	2	1/2"	20
	E020330015	EPV-15 PVC VM	ELETRODUTO RÍGIDO PESADO PVC VERMELHO 3/4"	2,5	3/4"	20
	E020330020	EPV-20 PVC VM	ELETRODUTO RÍGIDO PESADO PVC VERMELHO 1"	2,8	1"	10
	E020330025	EPV-25 PVC VM	ELETRODUTO RÍGIDO PESADO PVC VERMELHO 1.1/4"	2,9	1.1/4"	5
	E020330030	EPV-30 PVC VM	ELETRODUTO RÍGIDO PESADO PVC VERMELHO 1.1/2"	3,0	1.1/2"	5
	E020330035	EPV-35 PVC VM	ELETRODUTO RÍGIDO PESADO PVC VERMELHO 2"	3,1	2"	5

TUBOS

ELETROWETZEL PLASTIK MAX (SEM ROSCA)



	CÓDIGO	REFERÊNCIA	DESCRIÇÃO	ESPESSURA (mm)	BITOLA	QT. EMB.
	E020330210	EMV-10 PVC VM	ELETROWETZEL RÍGIDO PLASTIK MAX PVC VERMELHO 1/2"	1,5	1/2"	20
	E020330215	EMV-15 PVC VM	ELETROWETZEL RÍGIDO PLASTIK MAX PVC VERMELHO 3/4"	1,5	3/4"	20
	E020330220	EMV-20 PVC VM	ELETROWETZEL RÍGIDO PLASTIK MAX PVC VERMELHO 1"	1,7	1"	10





ELETROWETZEL PLASTIK STANDARD (SEM ROSCA)

	CÓDIGO	REFERÊNCIA	DESCRIÇÃO	ESPESSURA (mm)	BITOLA	QT. EMB.
	E020330110	ESV-10 PVC VM	ELETROWETZEL RÍGIDO PLASTIK STANDARD PVC VERMELHO 1/2"	1,2	1/2"	20
	E020330115	ESV-15 PVC VM	ELETROWETZEL RÍGIDO PLASTIK STANDARD PVC VERMELHO 3/4"	1,2	3/4"	20
	E020330120	ESV-20 PVC VM	ELETROWETZEL RÍGIDO PLASTIK STANDARD PVC VERMELHO 1"	1,4	1"	10

ABRAÇADEIRA



	CÓDIGO	REFERÊNCIA	DESCRIÇÃO	BITOLA	QT. EMB.
	E015530010	ABV-10 PP VM	ABRAÇADEIRA VERMELHA 1/2"	1/2"	50
	E015530015	ABV-15 PP VM	ABRAÇADEIRA VERMELHA 3/4"	3/4"	50
	E015530020	ABV-20 PP VM	ABRAÇADEIRA VERMELHA 1"	1"	50

LUVA (SEM ROSCA)

	CÓDIGO	REFERÊNCIA	DESCRIÇÃO	BITOLA	QT. EMB.
	E015230010	LV-10 PVC VM	LUVA SEM ROSCA VERMELHA 1/2"	1/2"	20
	E015230015	LV-15 PVC VM	LUVA SEM ROSCA VERMELHA 3/4"	3/4"	20
	E015230020	LV-20 PVC VM	LUVA SEM ROSCA VERMELHA 1"	1"	20

ACESSÓRIOS PVC VERMELHO



BUCHA DE REDUÇÃO (SEM ROSCA)

	CÓDIGO	REFERÊNCIA	DESCRIÇÃO	BITOLA	QT. EMB.
	E015430010	BRV-15/10 PVC VM	BUCHA DE REDUÇÃO SEM ROSCA VERMELHA 3/4x1/2"	3/4" X 1/2"	20
	E015430015	BRV-20/15 PVC VM	BUCHA DE REDUÇÃO SEM ROSCA VERMELHA 1x3/4"	1" X 3/4"	20



APLICAÇÃO DE BUCHA DE REDUÇÃO EM CAIXA FIXA





CURVA 45° PLASTIK MAX (COM DUAS BOLSAS)

	CÓDIGO	REFERÊNCIA	DESCRIÇÃO	BITOLA	QT. EMB.
	E020630010	C45V-10 PVC VM	CURVA 45° C/ 2 BOLSAS VERMELHA 1/2"	1/2"	10
	E020630015	C45V-15 PVC VM	CURVA 45° C/ 2 BOLSAS VERMELHA 3/4"	3/4"	10
	E020630020	C45V-20 PVC VM	CURVA 45° C/ 2 BOLSAS VERMELHA 1"	1"	10



CURVA 90° PLASTIK MAX (COM DUAS BOLSAS)

	CÓDIGO	REFERÊNCIA	DESCRIÇÃO	BITOLA	QT. EMB.
	E020130010	C90V-10 PVC VM	CURVA 90° C/ 2 BOLSAS VERMELHA 1/2"	1/2"	10
	E020130015	C90V-15 PVC VM	CURVA 90° C/ 2 BOLSAS VERMELHA 3/4"	3/4"	10
	E020130020	C90V-20 PVC VM	CURVA 90° C/ 2 BOLSAS VERMELHA 1"	1"	10

CURVA 90° PLASTIK STANDARD (COM DUAS BOLSAS)

	CÓDIGO	REFERÊNCIA	DESCRIÇÃO	BITOLA	QT. EMB.
	E020131010	CS90V-10 PVC VM	CURVA STANDARD 90° C/ 2 BOLSAS VERMELHA 1/2"	1/2"	10
	E020131015	CS90V-15 PVC VM	CURVA STANDARD 90° C/ 2 BOLSAS VERMELHA 3/4"	3/4"	10
	E020131020	CS90V-20 PVC VM	CURVA STANDARD 90° C/ 2 BOLSAS VERMELHA 1"	1"	10

COTOVELO 90° (COM TAMPA VIGIA SEM ROSCA)

	CÓDIGO	REFERÊNCIA	DESCRIÇÃO	BITOLA	QT. EMB.
	E015330010	CV-10 PVC VM	COTOVELO C/ TAMPA VIGIA EM PVC SEM ROSCA VERMELHO 1/2"	1/2"	20
	E015330015	CV-15 PVC VM	COTOVELO C/ TAMPA VIGIA EM PVC SEM ROSCA VERMELHO 3/4"	3/4"	20
	E015330020	CV-20 PVC VM	COTOVELO C/ TAMPA VIGIA EM PVC SEM ROSCA VERMELHO 1"	1"	20

LINHA INDUSTRIE

MECANISMOS MODULARES



CONHEÇA MAIS SOBRE

- COMPATÍVEL COM AS TAMPAS MODULARES PARA POLIWETZEL E CONDULETZEL.
- DESENVOLVIDOS PARA INSTALAÇÕES ELÉTRICAS INDUSTRIAIS DE BAIXA TENSÃO.

MÓDULOS ALL BLACK SÃO RECOMENDADOS PARA USO EM CAIXAS DA LINHA PRETO.



LINHA INDUSTRIE | MECANISMOS MODULARES

	CÓDIGO	REFERÊNCIA	DESCRIÇÃO	COR	QT. EMB.
	E011100180	CAMPAINHA CIGARRA BIV BR	MÓDULO CAMPAINHA CIGARRA BIVOLT	BRANCO	10
	E011100140	CARREGADOR USB 5.0V 2.0A BR	MÓDULO CARREGADOR USB 5.0V 2.0A	BRANCO	10
	E011100125	INT PAR 10A/250V BR	MÓDULO INTERRUPTOR PARALELO 10A-250V	BRANCO	25
	E011100115	INT SIM 10A/250V BR	MÓDULO INTERRUPTOR SIMPLES 10A-250V	BRANCO	25
	E011100130	MÓDULO CEGO C/2 PÇS BR	MÓDULO CEGO C/2 PÇS	BRANCO	25
	E011100185	MOLDURA P/ RJ45 C/2 PÇS BR	MÓDULO RJ45 C/2 PÇS	BRANCO	25
	E011100165	MÓDULO SAÍDA FIO C/2 PÇS BR	MÓDULO SAÍDA FIO C/2 PÇS	BRANCO	25
	E011100170	PULS CAMP 10A/250V BR	MÓDULO PULSADOR CAMPAINHA 10A-250V	BRANCO	10
	E011100160	PULS CAMP UNIV 10A/250V BR	MÓDULO PULSADOR CAMPAINHA UNIVERSAL 10A-250V	BRANCO	10
	E011100110	TOM 2P+T 10A 250V BR	MÓDULO TOMADA 2P+T 10A-250V	BRANCO	25
	E011100150	TOM 2P+T 10A 250V VM	MÓDULO TOMADA 2P+T 10A-250V	VERMELHO	25
	E011100120	TOM 2P+T 20A 250V BR	MÓDULO TOMADA 2P+T 20A-250V	BRANCO	25
	E011100175	TOM 2P+T 20A 250V VM	MÓDULO TOMADA 2P+T 20A-250V	VERMELHO	25
	E011100135	TOM ANTENA TV BR	MÓDULO TOMADA ANTENA TV	BRANCO	25
	E011100145	TOM RJ11 2F BR	MÓDULO TOMADA RJ11 2 FIOS	BRANCO	25
	E011100155	TOM RJ45 CAT 5E BR	MÓDULO TOMADA RJ45 CAT 5E	BRANCO	25
	E011100205	TOM RJ45 CAT 6 BR	MÓDULO TOMADA RJ45 CAT 6E	BRANCO	25







Conheça os módulos da linha

All Black



Modernidade
e Elegância

LINHA INDUSTRIE | MECANISMOS MODULARES - All Black

	CÓDIGO	REFERÊNCIA	DESCRIÇÃO	COR	QT. EMB.
	E011100225	INT PAR 10A/250V AB	MÓDULO INTERRUPTOR PARALELO 10A-250V	PRETO	25
	E011100215	INT SIM 10A/250V AB	MÓDULO INTERRUPTOR SIMPLES 10A-250V	PRETO	25
	E011100230	MÓDULO CEGO C/2 PÇS AB	MÓDULO CEGO C/ 2 PÇS	PRETO	25
	E011100210	TOM 2P+T 10A 250V AB	MÓDULO TOMADA 2P+T 10A-250V	PRETO	25
	E011100220	TOM 2P+T 20A 250V AB	MÓDULO TOMADA 2P+T 20A-250V	PRETO	25
	E011100240	MOLDURA P/ RJ45 AB	MÓDULO RJ45	PRETO	25
	E011100235	TOM RJ45 CAT 5E AB	MÓDULO TOMADA RJ45 CAT 5E	PRETO	25

PRENSA CABOS



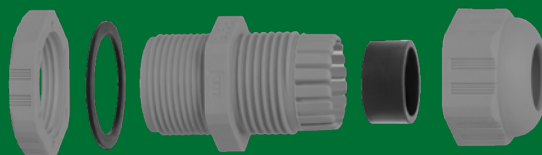

CONHEÇA MAIS SOBRE

- DISPONÍVEL NAS ROSCAS BSP, NPT, PG E MÉTRICA
- NAS CORES CINZA E PRETO
- GRAU DE PROTEÇÃO IP68



**CONECTOR PRENSA CABO NYLON CURTO
COM ROSCA BSP | COM CONTRAPORCA**

	CÓDIGO	REFERÊNCIA	Ø CABO (mm)	COR DO PRENSA CABO	BITOLA	QT. EMB.
	E019202010	PC HD BSP CC+P-1/4" CZ	3,5 - 6,5	CINZA	1/4"	50
	E019202020	PC HD BSP CC+P-5 CZ	5,0 - 10,0	CINZA	3/8"	50
	E019202030	PC HD BSP CC+P-10 CZ	6,0 - 12,0	CINZA	1/2"	50
	E019202040	PC HD BSP CC+P-15 CZ	13,0 - 18,0	CINZA	3/4"	50
	E019202050	PC HD BSP CC+P-20 CZ	18,0 - 24,0	CINZA	1"	50
	E019202060	PC HD BSP CC+P-25 CZ	22,0 - 32,0	CINZA	1.1/4"	25
	E019202070	PC HD BSP CC+P-30 CZ	32,0 - 37,0	CINZA	1.1/2"	25
	E019202080	PC HD BSP CC+P-35 CZ	37,0 - 44,0	CINZA	2"	20
	*E019202090	PC HD BSP CC+P-40 CZ	45,0 - 55,0	CINZA	2.1/2"	2
	*E019202100	PC HD BSP CC+P-45 CZ	55,0 - 66,0	CINZA	3"	1
	*E019202110	PC HD BSP CC+P-55 CZ	77,0 - 88,0	CINZA	4"	1
	E019222010	PC HD BSP CP+P-1/4" PR	3,5 - 6,5	PRETO	1/4"	50
	E019222020	PC HD BSP CP+P-5 PR	5,0 - 10,0	PRETO	3/8"	50
	E019222030	PC HD BSP CP+P-10 PR	6,0 - 12,0	PRETO	1/2"	50
	E019222040	PC HD BSP CP+P-15 PR	13,0 - 18,0	PRETO	3/4"	50
	E019222050	PC HD BSP CP+P-20 PR	18,0 - 24,0	PRETO	1"	50
	E019222060	PC HD BSP CP+P-25 PR	22,0 - 32,0	PRETO	1.1/4"	25
	E019222070	PC HD BSP CP+P-30 PR	32,0 - 37,0	PRETO	1.1/2"	25
	E019222080	PC HD BSP CP+P-35 PR	37,0 - 44,0	PRETO	2"	20
	*E019222090	PC HD BSP CP+P-40 PR	45,0 - 55,0	PRETO	2.1/2"	2
	*E019222100	PC HD BSP CP+P-45 PR	55,0 - 66,0	PRETO	3"	1
	*E019222110	PC HD BSP CP+P-55 PR	77,0 - 88,0	PRETO	4"	1

*ENTREGA SOB CONSULTA

*ENTREGA SOB CONSULTA

ROSCA NPT

**CONECTOR PRENSA CABO NYLON LONGO
COM ROSCA NPT | SEM CONTRAPORCA**

	CÓDIGO	REFERÊNCIA	Ø CABO (mm)	COR DO PRENSA CABO	BITOLA	QT. EMB.
	E019502030	PC HD NPT LC+P-10 CZ	6,5 - 12,0	CINZA	1/2"	50
	E019502040	PC HD NPT LC+P-15 CZ	13,0 - 17,0	CINZA	3/4"	50
	E019502050	PC HD NPT LC+P-20 CZ	18,0 - 25,0	CINZA	1"	25
	E019502080	PC HD NPT LC+P-35 CZ	37,0 - 44,0	CINZA	2"	20
	E019522030	PC HD NPT LP+P-10 PR	6,5 - 12,0	PRETO	1/2"	50
	E019522040	PC HD NPT LP+P-15 PR	13,0 - 17,0	PRETO	3/4"	50
	E019522050	PC HD NPT LP+P-20 PR	18,0 - 25,0	PRETO	1"	25
	E019522080	PC HD NPT LP+P-35 PR	37,0 - 44,0	PRETO	2"	20

ROSCA PG

**CONECTOR PRENSA CABO NYLON CURTO
COM ROSCA PG | COM CONTRAPORCA | COM VEDAÇÃO**

	CÓDIGO	REFERÊNCIA	Ø CABO (mm)	COR DO PRENSA CABO	ROSCA	QT. EMB.
	E019002020	PC HD PG CC+P-9 CZ	4,0 - 8,0	CINZA	PG 9	50
	E019002030	PC HD PG CC+P-11 CZ	5,0 - 10,0	CINZA	PG 11	50
	E019002040	PC HD PG CC+P-13,5 CZ	6,0 - 12,0	CINZA	PG 13,5	50
	E019002050	PC HD PG CC+P-16 CZ	10,0 - 14,0	CINZA	PG 16	50

**CONECTOR PRENSA CABO NYLON CURTO
COM ROSCA BSP | COM CONTRAPORCA**



	CÓDIGO	REFERÊNCIA	Ø CABO (mm)	COR DO PRENSA CABO	BITOLA	QT. EMB.
	E019200010	PN BSP CC+P-1/4" CZ	3,0 - 6,5	CINZA	1/4"	50
	E019200020	PN BSP CC+P-5 CZ	5,0 - 10,0	CINZA	3/8"	50
	E019200030	PN BSP CC+P-10 CZ	6,0 - 12,0	CINZA	1/2"	50
	E019200040	PN BSP CC+P-15 CZ	13,0 - 18,0	CINZA	3/4"	50
	E019200050	PN BSP CC+P-20 CZ	18,0 - 25,0	CINZA	1"	50
	E019200060	PN BSP CC+P-25 CZ	22,0 - 32,0	CINZA	1 1/4"	25
	E019200070	PN BSP CC+P-30 CZ	32,0 - 38,0	CINZA	1 1/2"	25
	E019200080	PN BSP CC+P-35 CZ	37,0 - 44,0	CINZA	2"	20
	E019220010	PN BSP CP+P-1/4" PR	3,0 - 6,5	PRETO	1/4"	50
	E019220020	PN BSP CP+P-5 PR	5,0 - 10,0	PRETO	3/8"	50
	E019220030	PN BSP CP+P-10 PR	6,0 - 12,0	PRETO	1/2"	50
	E019220040	PN BSP CP+P-15 PR	13,0 - 18,0	PRETO	3/4"	50
	E019220050	PN BSP CP+P-20 PR	18,0 - 25,0	PRETO	1"	50
	E019220060	PN BSP CP+P-25 PR	22,0 - 32,0	PRETO	1 1/4"	25
	E019220070	PN BSP CP+P-30 PR	32,0 - 38,0	PRETO	1 1/2"	25
	E019220080	PN BSP CP+P-35 PR	37,0 - 44,0	PRETO	2"	20

ROSCA NPT

**CONECTOR PRENSA CABO NYLON LONGO
COM ROSCA NPT | SEM CONTRAPORCA**



	CÓDIGO	REFERÊNCIA	Ø CABO (mm)	COR DO PRENSA CABO	BITOLA	QT. EMB.
	E019500010	PN NPT LC-1/4" CZ	3,0 - 6,5	CINZA	1/4"	50
	E019500020	PN NPT LC-5 CZ	5,0 - 10,0	CINZA	3/8"	50
	E019500030	PN NPT LC-10 CZ	6,0 - 12,0	CINZA	1/2"	50
	E019500040	PN NPT LC-15 CZ	13,0 - 18,0	CINZA	3/4"	50
	E019500050	PN NPT LC-20 CZ	18,0 - 25,0	CINZA	1"	50
	E019500060	PN NPT LC-25 CZ	22,0 - 32,0	CINZA	1.1/4"	25
	E019500070	PN NPT LC-30 CZ	32,0 - 38,0	CINZA	1.1/2"	25
	E019500080	PN NPT LC-35 CZ	37,0 - 44,0	CINZA	2"	20
	E019520010	PN NPT LP-1/4" PR	3,0 - 6,5	PRETO	1/4"	50
	E019520020	PN NPT LP-5 PR	5,0 - 10,0	PRETO	3/8"	50
	E019520030	PN NPT LP-10 PR	6,0 - 12,0	PRETO	1/2"	50
	E019520040	PN NPT LP-15 PR	13,0 - 18,0	PRETO	3/4"	50
	E019520050	PN NPT LP-20 PR	18,0 - 25,0	PRETO	1"	50
	E019520060	PN NPT LP-25 PR	22,0 - 32,0	PRETO	1.1/4"	25
	E019520070	PN NPT LP-30 PR	32,0 - 38,0	PRETO	1.1/2"	25
	E019520080	PN NPT LP-35 PR	37,0 - 44,0	PRETO	2"	20

**CONECTOR PRENSA CABO NYLON CURTO
COM ROSCA PG | COM CONTRAPORCA | COM VEDAÇÃO**



	CÓDIGO	REFERÊNCIA	Ø CABO (mm)	COR DO PRENSA CABO	ROSCA	QT. EMB.
	E019000010	PC PG CC+P-7 CZ	3,0 - 6,5	CINZA	PG 7	50
	E019000020	PC PG CC+P-9 CZ	4,0 - 8,0	CINZA	PG 9	50
	E019000030	PC PG CC+P-11 CZ	5,0 - 10,0	CINZA	PG 11	50
	E019000040	PC PG CC+P-13,5 CZ	6,0 - 12,0	CINZA	PG 13,5	50
	E019000050	PC PG CC+P-16 CZ	10,0 - 14,0	CINZA	PG 16	50
	E019000060	PC PG CC+P-21 CZ	13,0 - 18,0	CINZA	PG 21	50
	E019000070	PC PG CC+P-29 CZ	18,0 - 25,0	CINZA	PG 29	50
	E019000080	PC PG CC+P-36 CZ	22,0 - 32,0	CINZA	PG 36	50
	E019000090	PC PG CC+P-42 CZ	32,0 - 38,0	CINZA	PG 42	50
	E019000100	PC PG CC+P-48 CZ	37,0 - 44,0	CINZA	PG 48	50
	E019020010	PC PG CP+P-7 PR	3,0 - 6,5	PRETO	PG 7	50
	E019020020	PC PG CP+P-9 PR	4,0 - 8,0	PRETO	PG 9	50
	E019020030	PC PG CP+P-11 PR	5,0 - 10,0	PRETO	PG 11	50
	E019020040	PC PG CP+P-13,5 PR	6,0 - 12,0	PRETO	PG 13,5	50
	E019020050	PC PG CP+P-16 PR	10,0 - 14,0	PRETO	PG 16	50
	E019020060	PC PG CP+P-21 PR	13,0 - 18,0	PRETO	PG 21	50
	E019020070	PC PG CP+P-29 PR	18,0 - 25,0	PRETO	PG 29	50
	E019020080	PC PG CP+P-36 PR	22,0 - 32,0	PRETO	PG 36	50
	E019020090	PC PG CP+P-42 PR	32,0 - 38,0	PRETO	PG 42	50
	E019020100	PC PG CP+P-48 PR	37,0 - 44,0	PRETO	PG 48	50

ROSCA PG

**CONECTOR PRENSA CABO NYLON LONGO
COM ROSCA PG | COM CONTRAPORCA | COM VEDAÇÃO**

	CÓDIGO	REFERÊNCIA	Ø CABO (mm)	COR DO PRENSA CABO	ROSCA	QT. EMB.
	E019100010	PC PG LC+P-7 CZ	3,0 - 6,5	CINZA	PG 7	50
	E019100020	PC PG LC+P-9 CZ	4,0 - 8,0	CINZA	PG 9	50
	E019100030	PC PG LC+P-11 CZ	5,0 - 10,0	CINZA	PG 11	50
	E019100040	PC PG LC+P-13,5 CZ	6,0 - 12,0	CINZA	PG 13,5	50
	E019100050	PC PG LC+P-16 CZ	10,0 - 14,0	CINZA	PG 16	50
	E019100060	PC PG LC+P-21 CZ	13,0 - 18,0	CINZA	PG 21	50
	E019100070	PC PG LC+P-29 CZ	18,0 - 25,0	CINZA	PG 29	50
	E019120010	PC PG LP+P-7 PR	3,0 - 6,5	PRETO	PG 7	50
	E019120020	PC PG LP+P-9 PR	4,0 - 8,0	PRETO	PG 9	50
	E019120030	PC PG LP+P-11 PR	5,0 - 10,0	PRETO	PG 11	50
	E019120040	PC PG LP+P-13,5 PR	6,0 - 12,0	PRETO	PG 13,5	50
	E019120050	PC PG LP+P-16 PR	10,0 - 14,0	PRETO	PG 16	50
	E019120060	PC PG LP+P-21 PR	13,0 - 18,0	PRETO	PG 21	50
	E019120070	PC PG LP+P-29 PR	18,0 - 25,0	PRETO	PG 29	50

**CONECTOR PRENSA CABO NYLON CURTO
COM ROSCA PG | COM CONTRAPORCA | COM VEDAÇÃO**

	CÓDIGO	REFERÊNCIA	Ø CABO (mm)	COR DO PRENSA CABO	ROSCA	QT. EMB.
	E019300010	PC M CC+P 12x1,5 CZ	3,0 - 6,5	CINZA	M12x1,5	50
	E019300020	PC M CC+P 16x1,5 CZ	4,0 - 8,0	CINZA	M16x1,5	50
	E019300030	PC M CC+P 18x1,5 CZ	5,0 - 10,0	CINZA	M18x1,5	50
	E019300040	PC M CC+P 20x 1,5 CZ	6,0 - 12,0	CINZA	M20x1,5	50
	E019300050	PC M CC+P 22x 1,5 CZ	10,0 - 14,0	CINZA	M22x1,5	50
	E019300070	PC M CC+P 27x 1,5 CZ	13,0 - 18,0	CINZA	M27x1,5	50
	E019300080	PC M CC+P 36x 1,5 CZ	18,0 - 25,0	CINZA	M36x1,5	25
	E019300090	PC M CC+P 40x 1,5 CZ	22,0 - 32,0	CINZA	M40x1,5	50
	E019300100	PC M CC+P 50x 1,5 CZ	32,0 - 38,0	CINZA	M50x1,5	25
	E019300110	PC M CC+P 63x 1,5 CZ	37,0 - 44,0	CINZA	M63x1,5	10
	E019320010	PC M CP+P 12x1,5 PR	3,0 - 6,5	PRETO	M12x1,5	50
	E019320020	PC M CP+P 16x1,5 PR	4,0 - 8,0	PRETO	M16x1,5	50
	E019320030	PC M CP+P 18x 1,5 PR	5,0 - 10,0	PRETO	M18x1,5	50
	E019320040	PC M CP+P 20x 1,5 PR	6,0 - 12,0	PRETO	M20x1,5	50
	E019320050	PC M CP+P 22x 1,5 PR	10,0 - 14,0	PRETO	M22x1,5	50
	E019320070	PC M CP+P 27x 1,5 PR	13,0 - 18,0	PRETO	M27x1,5	50
	E019320080	PC M CP+P 36x 1,5 PR	18,0 - 25,0	PRETO	M36x1,5	25
	E019320090	PC M CP+P 40x 1,5 PR	22,0 - 32,0	PRETO	M40x1,5	25
	E019320100	PC M CP+P 50x 1,5 PR	32,0 - 38,0	PRETO	M50x1,5	25

ROSCA
MÉTRICA

CONECTOR PRENSA CABO NYLON LONGO
COM ROSCA PG | COM CONTRAPORCA | COM VEDAÇÃO

	CÓDIGO	REFERÊNCIA	Ø CABO (mm)	COR DO PRENSA CABO	ROSCA	QT. EMB.
	E019400020	PC M LC+P 16x1,5 CZ	4,0 - 8,0	CINZA	M16x1,5	50
	E019400030	PC M LC+P 18x1,5 CZ	5,0 - 10,0	CINZA	M18x1,5	50
	E019400040	PC M LC+P 20x 1,5 CZ	6,0 - 12,0	CINZA	M20x1,5	50
	E019320110	PC M LC+P 63x 1,5 CZ	37,0 - 44,0	CINZA	M63x1,5	50
	E019420020	PC M LP+P 16x1,5 PR	4,0 - 8,0	PRETO	M16x1,5	50
	E019420030	PC M LP+P 18x1,5 PR	5,0 - 10,0	PRETO	M18x1,5	50
	E019420040	PC M LP+P 20x 1,5 PR	6,0 - 12,0	PRETO	M20x1,5	50

CAIXA DE PASSAGEM

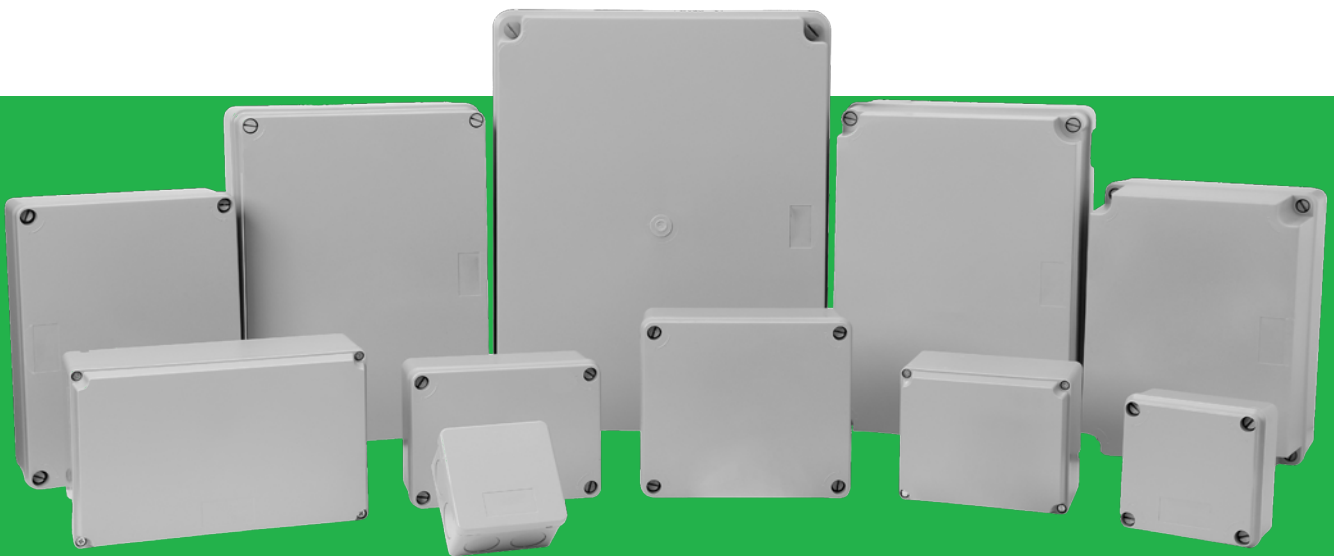

CONHEÇA MAIS SOBRE

- DISPONÍVEL COM **CHASSI** PARA FIXAÇÃO DE COMPONENTES ELÉTRICOS
- GRAU DE PROTEÇÃO DE **IP44 A IP65** (CONFORME MODELO)

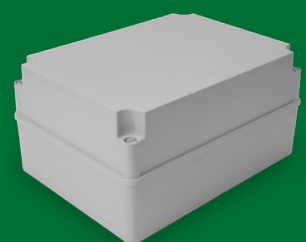
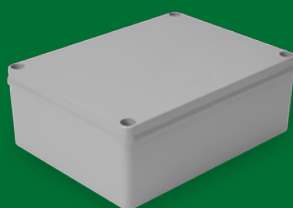
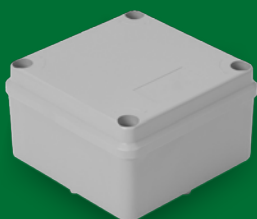

CAIXA DE PASSAGEM

	CÓDIGO	REFERÊNCIA	DESCRIÇÃO	GRAU IP	MODELO	QT. EMB.
	E020040310	CP-80X80 CEGA C/ TO	CAIXA DE PASSAGEM 80X80 CEGA, TAMPA OPACA	IP44	-	1
	E020040320	CP-102X102X55 CEGA C/ TO	CAIXA DE PASSAGEM 102X102X55 CEGA, TAMPA OPACA	IP65	-	1
	E020040330	CP-154X110X70 CEGA C/ TO	CAIXA DE PASSAGEM 154X110X70 CEGA, TAMPA OPACA	IP65	-	1
	E020040340	CP-170X145X90 CEGA C/ TO	CAIXA DE PASSAGEM 170X145X90 CEGA, TAMPA OPACA	IP65	-	1
	E020040350	CP-234X174X90 CEGA C/ TO BAIXA	CAIXA DE PASSAGEM 234X174X90 CEGA, TAMPA OPACA BAIXA	IP65	BAIXA	1
	E020040360	CP-234X174X143 CEGA C/ TO ALTA	CAIXA DE PASSAGEM 234X174X143 CEGA, TAMPA OPACA ALTA	IP65	ALTA	1
	E020040370	CP-300X220X120 CEGA C/ TO BAIXA	CAIXA DE PASSAGEM 300X220X120 CEGA, TAMPA OPACA BAIXA	IP65	BAIXA	1
	E020040380	CP-300X220X148 CEGA C/ TO ALTA	CAIXA DE PASSAGEM 300X220X148 CEGA, TAMPA OPACA ALTA	IP65	ALTA	1
	E020040390	CP-384X304X120 CEGA C/ TO CEGA BAIXA	CAIXA DE PASSAGEM 384X304X120 CEGA, TAMPA OPACA BAIXA	IP65	BAIXA	1



OPÇÕES ESPECIAIS

Sob consulta é possível adquirir a tampa transparente, para facilitar a identificação dos componentes internos.

RECOMENDAÇÕES DE INSTALAÇÃO

Para garantir o Grau de Proteção IP, utilize os suportes para caixa de passagem. Recomenda-se que os suportes sejam fixados nas caixas com a Cola Permabond. Ambos os produtos estão disponíveis na página seguinte.

CAIXA DE PASSAGEM

CHASSI PARA CAIXA DE PASSAGEM

	CÓDIGO	REFERÊNCIA	DESCRIÇÃO	QT. EMB.
	E020040400	CHASSI PARA CP-102	CHASSI PARA CAIXA DE PASSAGEM 102X102	1
	E020040410	CHASSI PARA CP-154	CHASSI PARA CAIXA DE PASSAGEM 154X110	1
	E020040420	CHASSI PARA CP-170	CHASSI PARA CAIXA DE PASSAGEM 170X145	1
	E020040440	CHASSI PARA CP-234	CHASSI PARA CAIXA DE PASSAGEM 234X174	1
	E020040450	CHASSI PARA CP-300	CHASSI PARA CAIXA DE PASSAGEM 300X220	1
	E020040460	CHASSI PARA CP-384	CHASSI PARA CAIXA DE PASSAGEM 384X300	1

SUPOORTE PARA CAIXA DE PASSAGEM

	CÓDIGO	REFERÊNCIA	DESCRIÇÃO	QT. EMB.
	E020040470	SUP. 2FV	SUPOORTE 2 FUROS VERTICAIS	1
	E020040490	SUP. 2FHP	SUPOORTE 2 FUROS HORIZONTAIS TAM "P"	1
	E020040500	SUP. 2FHG	SUPOORTE 2 FUROS HORIZONTAIS TAM "G"	1
	E020040510	SUP. 4FHR	SUPOORTE 4 FUROS HORIZONTAIS RETANGULAR	1
	E020040520	SUP. 4FHQ	SUPOORTE 4 FUROS HORIZONTAIS QUADRADO	1
	E020040530	SUP. CINTA	SUPOORTE CINTA	1

COLA PARA FIXAÇÃO DE CAIXAS DE PASSAGEM

	CÓDIGO	REFERÊNCIA	DESCRIÇÃO	QT. EMB.
	E020040560	COLA PERMABOND	COLA PERMABOND	1



A series of horizontal lines for writing, consisting of 28 evenly spaced lines.





WETZEL.COM.BR